

**CIOCCOLATO**  
E ACCESSORI

**CHOCOLATE**  
AND ACCESSORIES

Pg 2

**STAMPI**  
SEMIFREDDO E COTTURA

**MOULDS**  
FOR SEMIFREDDO AND BAKING

Pg 90

**DECORAZIONI**  
E COLORANTI

**DECORATIONS**  
AND COLOURS

Pg 120

**ATTREZZATURA**  
E ACCESSORI PER PASTICCERIA

**EQUIPMENT**  
AND ACCESSORIES FOR PASTRY

Pg 152

**GELATO**  
E ACCESSORI

**ICE CREAM**  
AND ACCESSORIES

Pg 230

**MONOUSO**  
E TAKE AWAY

**DISPOSABLE**  
AND TAKE AWAY

Pg 246

**DISPLAY**  
E CATERING

**DISPLAYS**  
AND CATERING

Pg 260

**ACCESSORI**  
E ATTREZZATURE PER CATERING

**ACCESSORIES**  
AND EQUIPMENT FOR CATERING

Pg 290

**ALZATE**  
PER DOLCI E SALATI

**CAKE STANDS**  
FOR SWEET AND SAVOURY FOODS

Pg 304

# CIOCCOLATO

E ACCESSORI

# CHOCOLATE

AND ACCESSORIES



## STAMPI 3D IN SILICONE SILICONE 3D MOULDS

Nuova linea di stampi in silicone per realizzare forme tridimensionali. La gamma include differenti tematiche: Halloween, Natale e animali.

New line of silicone moulds for the production of three-dimensional shapes. The range includes subjects dedicated to different themes: Halloween, Christmas and animals.

*Silicone*  
**Idea**  
sweet creation



Cod.	Misure - Size	Descrizione - Description
<b>30SM001</b>	85x40 h117mm	renna con cuore - reindeer with heart

Cod.	Misure - Size	Descrizione - Description
<b>30SM002</b>	80x70x h135mm	orsetto babbo natale - santa claus bear



Cod.	Misure - Size	Descrizione - Description
<b>30SM003</b>	60x65 h130mm	babbo natale - santa claus

Cod.	Misure - Size	Descrizione - Description
<b>30SM004</b>	90x75 h130mm	pupazzo con lanterna - snowman with lantern



Cod.	Misure - Size	Descrizione - Description
<b>30SM005</b>	77x55 h130mm	gufo - owl

Cod.	Misure - Size	Descrizione - Description
<b>30SM006</b>	80x50 h112mm	scoiattolo - squirrel

Cod.	Misure - Size	Descrizione - Description
<b>30SM009</b>	65x80 h100mm	renna simpatica - funny reindeer

Cod.	Misure - Size	Descrizione - Description
<b>30SM010</b>	80x60 h105mm	angioletto con libro - angel with book



Cod.	Misure - Size	Descrizione - Description
<b>30SM007</b>	125x75 h115mm	babbo natale gnomo - santa gnome

Cod.	Misure - Size	Descrizione - Description
<b>30SM008</b>	105x95 h125mm	pupazzo di neve - snowman with scarf

Cod.	Misure - Size	Descrizione - Description
<b>30SM018</b>	90x75 h130mm	angelo con cornetta - angel with trumpet

Cod.	Misure - Size	Descrizione - Description
<b>30SM017</b>	150x75 h120mm	presepe - nativity



Cod.	Misure - Size	Descrizione - Description
30SM013	75x55 h100mm	scheletro - skeleton



Cod.	Misure - Size	Descrizione - Description
30SM016	75x50 h90mm	Frankenstein



Cod.	Misure - Size	Descrizione - Description
30SM019	120x55 h95mm	vampiro - vampire



Cod.	Misure - Size	Descrizione - Description
30SM014	85x70 h85mm	zucca con gatto - pumpkin with cat



Cod.	Misure - Size	Descrizione - Description
30SM015	55x50 h85mm	Dracula



Cod.	Misure - Size	Descrizione - Description
30SM011	90x50 h30mm	bebè che dorme - sleeping baby
30SM012	112x75 h30mm	cuscino - pillow

STAMPI PROFESSIONALI PRALINE COMPONIBILI  
PROFESSIONAL MOULDS FOR MODULAR PRALINES



**New Material**  
Stampi - Moulds  
275x175mm

Salvaguardiamo la tua salute  
utilizzando materiali senza bisfenolo A.  
La temperatura consigliata per il lavaggio di questi stampi  
non deve superare i 60 °C.

We protect your health  
by using materials without bisphenol A.  
The recommended temperature for the washing  
of these moulds should not exceed 60 °C.



La pralina di cioccolato dal design  
moderno e minimalista lascia il po-  
sto ad un'assoluta novità dal sapore  
vintage.

**NOSTALGIC CHOCOLATE** è la  
nuova linea di stampi per realizzare  
praline di cioccolato che richiamano  
oggetti d'epoca: dal coinvolgen-  
te Juke Box all'amabile telefono a  
rotella, otto soggetti disponibili in 4  
kit da due stampi.

The modern and minimalist praline  
design gives way to the novelty of  
the vintage chocolates.

**NOSTALGIC CHOCOLATE** is a  
brand new collection of moulds for  
preparing pralines with shapes like  
the Juke Box, the rotary dial phone  
and many others.

Eight different subjects available in  
4 kits of 2 moulds each.

# TELEFONO & ABATJOUR

TELEPHONE & LAMP



12 gr

Produttività  
Capacity  
12 pcs  
24x34- h27mm



10 gr

Produttività  
Capacity  
16 pcs  
Ø27- h40mm



cod. MA4000

Kit 2 stampi: Telefono + Abatjour  
Kit 2 moulds: Telephone + Lamp



# POLTRONA & JUKE BOX

ARMCHAIR & JUKE BOX



11 gr

Produttività  
Capacity  
12 pcs  
35x17- h29mm



13 gr

Produttività  
Capacity  
12 pcs  
28x16- h37mm



cod. MA4002

Kit 2 stampi: Juke Box + Poltrona  
Kit 2 moulds: Juke Box + Armchair



# VALIGIE & FOTOCAMERA

LUGGAGES & CAMERA



12 gr

Produttività  
Capacity  
18 pcs  
34x21- h30mm



3 gr

10 gr

Produttività  
Capacity  
6+6 pcs  
35x13 h29 mm  
23x10 h19 mm



cod. MA4001

Kit 2 stampi: Fotocamera + Set Valigie  
Kit 2 moulds: Camera + Luggage Set



# BILANCIA & SVEGLIA

SCALE & ALARM CLOCK



12 gr

Produttività  
Capacity  
8 pcs  
36x30- h29mm



12 gr

Produttività  
Capacity  
14 pcs  
30x13- h40mm



cod. MA4003

Kit 2 stampi: Bilancia + Sveglia  
Kit 2 moulds: Scale + Alarm Clock



# STAMPI PROFESSIONALI PER PRALINE PROFESSIONAL MOULDS FOR PRALINES



<http://torgoborud.com.ua/formy-dlya-shokolada>

La qualità del materiale utilizzato per la produzione degli stampi Martellato garantisce un'ottimale produzione di decorazioni, soggetti e praline di cioccolato dall'indubbia lucentezza ed eleganza.  
The quality of the material used to produce Martellato moulds assures the best production of bright and elegant decorations, subjects and chocolate pralines.  
Misura - Size: 175x275mm



**NEW**

**MA1640**  
16 pcs 48x18,5 h19mm



**MA1002**  
28 pcs Ø30 h19mm



**MA1019**  
40 pcs 25x25 h23mm



**MA1025**  
30 pcs 33x22 h20mm



**MA1029**  
32 pcs 39x28 h17mm



**MA1032**  
32 pcs 38x22 h15mm

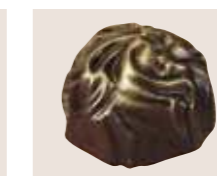

**MA1037**  
40 pcs Ø29 h21mm

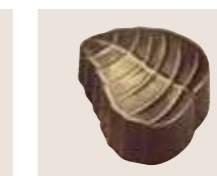

**MA1046**  
28 pcs 37x31 h16mm



**MA1064**  
36 pcs 35x23 h16mm



**MA1074**  
30 pcs 38x28 h18mm

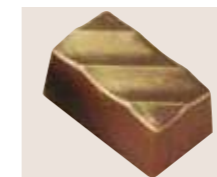

**MA1082**  
40 pcs 35x20 h17mm

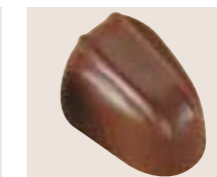

**MA1088**  
32 pcs 39x26 h19mm

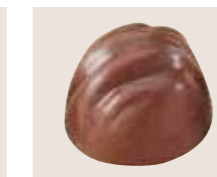

**MA1091**  
40 pcs Ø28 h24mm

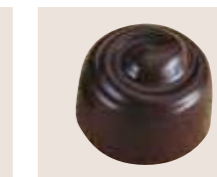

**MA1094**  
28 pcs Ø30 h22mm



**MA1281**  
130 pcs 17x12 h5mm

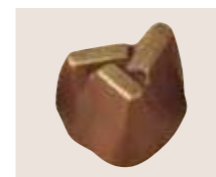

**MA1293**  
28 pcs Ø23 h21mm



**MA1303**  
28 pcs 27x27 h18mm

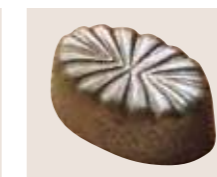

**MA1335**  
30 pcs 35x22 h15mm



**MA1350**  
30 pcs Ø28 h25mm

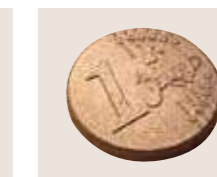

**MA1467**  
24 pcs Ø34 h4mm



**MA1493**  
28 pcs Ø28 h16mm

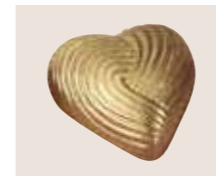

**MA1513**  
28 pcs 34x33 h11mm



**MA1521**  
28 pcs Ø28 h18mm

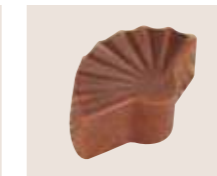

**MA1525**  
42 pcs 31x26 h15,5mm

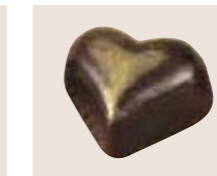

**MA1526**  
35 pcs 34,7x22 h16mm



**MA1527**  
35 pcs 31x24 h13mm

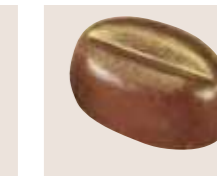

**MA1529**  
42 pcs 32x22 h15mm

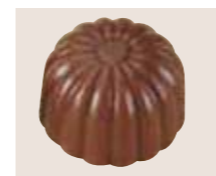

**MA1530**  
40 pcs Ø26 h19mm

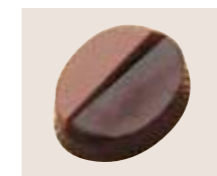

**MA1602**  
20 pcs 35x27 h12mm



**MA1603**  
24 pcs 32x23 h13mm



**MA1604**  
24 pcs 30x25 h15mm



**MA1605**  
15 pcs 40x32 h11mm



**MA1606**  
24 pcs 30x30 h12mm





**MA1607** 24 pcs Ø27 h17mm  
**MA1608** 20 pcs 33x25 h12mm  
**MA1609** 24 pcs 30x23 h18mm  
**MA1610** 24 pcs Ø29 h18mm  
**MA1611** 24 pcs Ø30 h15mm  
**MA1612** 20 pcs 38x30 h15mm



**MA1613** 15 pcs 40x42 h15mm  
**MA1614** 24 pcs 30x24 h12mm  
**MA1615** 20 pcs 38x25 h12mm  
**MA1616** 28 pcs 27x27 h13mm  
**MA1617** 24 pcs 31x23 h12mm  
**MA1618** 24 pcs Ø30 h20mm

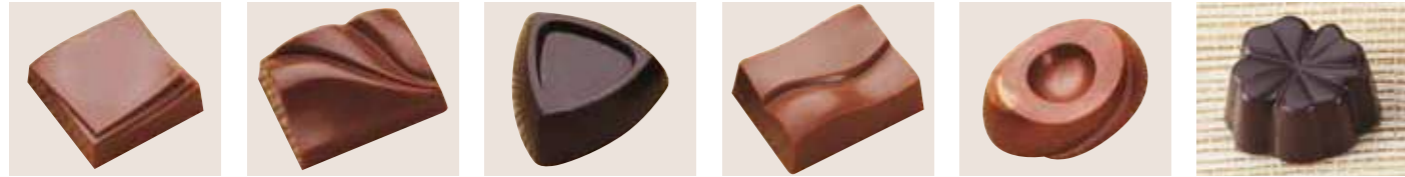

**MA1619** 18 pcs 29x29 h12mm  
**MA1620** 24 pcs 33x25 h12mm  
**MA1621** 24 pcs 33x33 h15mm  
**MA1622** 24 pcs 30x24 h12mm  
**MA1623** 20 pcs 40x30 h12mm  
**MA1624** 32 pcs 28x32 h15mm

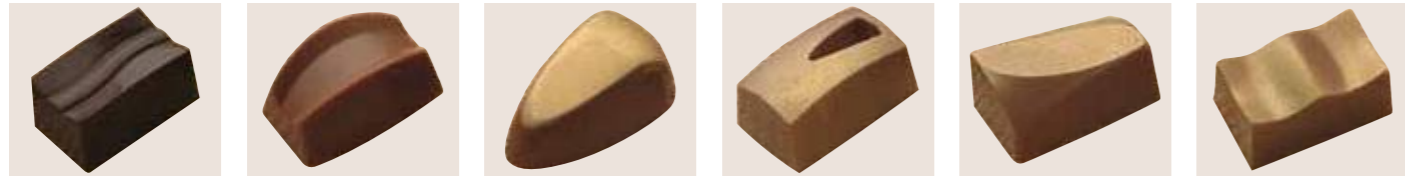

**MA1625** 30 pcs 30x18 h15mm  
**MA1626** 30 pcs 31x20 h16mm  
**MA1627** 30 pcs 35x20 h15mm  
**MA1628** 30 pcs 30x18 h15mm  
**MA1629** 30 pcs 30x18 h15mm  
**MA1630** 30 pcs 30x18 h15mm

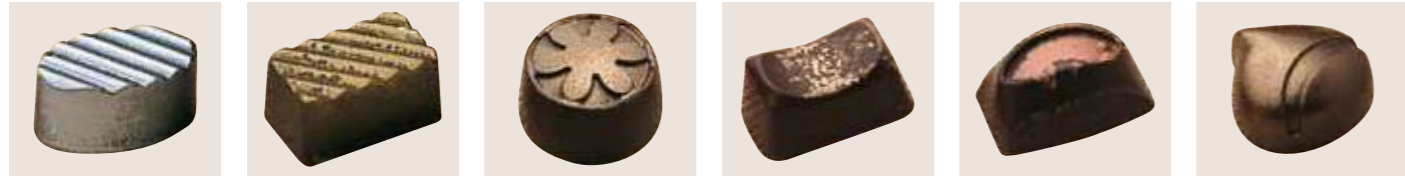

**MA1631** 30 pcs 30x18 h15mm  
**MA1632** 30 pcs 30x18 h15mm  
**MA1633** 35 pcs Ø26 h15mm  
**MA1634** 30 pcs 32x19 h15mm  
**MA1635** 30 pcs 32x22 h15mm  
**MA1636** 24 pcs 30x30 h15mm



**MA1637** 30 pcs 32x24 h15mm  
**MA1638** 30 pcs 34x25 h15mm  
**MA1701** 35 pcs 30x25 h15mm  
**MA1702** 35 pcs 30x25 h14mm  
**MA1703** 35 pcs 30x25 h14mm  
**MA1704** 35 pcs 30x25 h15mm



**MA1705** 35 pcs 30x25 h14mm  
**MA1706** 35 pcs 31x26 h14mm  
**MA1707** 35 pcs 30x25 h14mm  
**MA1800** 28 pcs 22x22 h22mm  
**MA1801** 28 pcs 26x20 h21mm  
**MA1802** 28 pcs Ø24 h21mm



**MA1803** 28 pcs 26x20 h21mm  
**MA1804** 28 pcs Ø25 h18,5mm  
**MA1900** 28 pcs 29x19 h16mm  
**MA1901** 28 pcs 27x23 h14mm  
**MA1902** 28 pcs 26x19 h16mm  
**MA1903** 28 pcs 28x20 h17mm



**MA1904** 28 pcs 30x20 h17,5mm  
**MA1905** 28 pcs 30,5x19,5 h18mm  
**MA1906** 28 pcs 30x19 h17mm  
**MA1907** 28 pcs 29,5x19 h17mm  
**MA1908** 28 pcs 26,5x22,5 h16,5mm  
**MA1909** 28 pcs 27,5x19,5 h17mm



**MA1958** 5x7 pcs 30x24 h17mm  
**MA1959** 5x7 pcs 30x24 h17mm



**MA1960** 35 pcs 30x25 h15mm  
**MA1961** 5x6 pcs 30x25 h25mm  
**MA1962** 30 pcs 31x27 h14mm  
**MA1963** 30 pcs Ø27 h20mm



**MA1964** 30 pcs Ø27 h20mm  
**MA1965** 30 pcs 25x25 h15mm  
**MA1966** 30 pcs 25x25 h15mm  
**MA1967** 30 pcs 25x25 h15mm  
**MA1968** 30 pcs 25x25 h15mm  
**MA1969** 30 pcs 40x20 h18mm



**MA1970** 30 pcs 40x18 h15mm  
**MA1971** 30 pcs 40x18 h16mm  
**MA1972** 30 pcs 26x26 h20mm  
**MA1973** 5x6 pcs 30x24 h20mm



**MA1974** 5x6 pcs 30x26 h16,5mm  
**MA1975** 5x6 pcs 31x22 h22mm



**MA1976** 32 pcs 33x26 h17mm  
**MA1977** 5x6 pcs 30x24 h11mm

**MA1978** 3x8 pcs 30x32 h5mm



**MA1979** 5x6 pcs 33x24 h18mm

**MA2002** 24 pcs 32x32 h4mm  
**MA2003** 28 pcs 20x20 h16mm

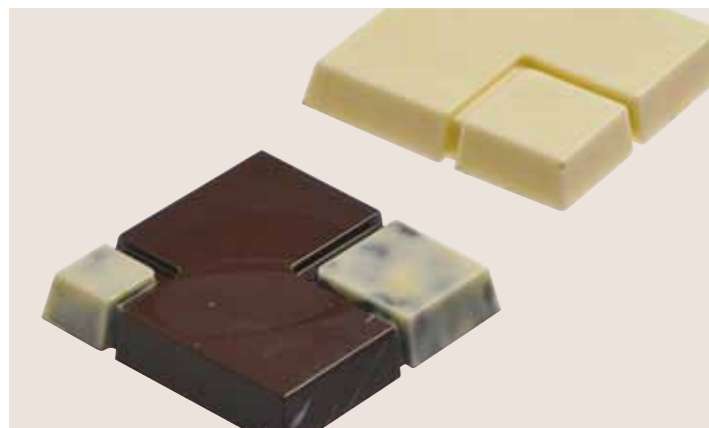

**MA1805**  
8 pcs 58x58 h10mm



**MA1807**  
3 pcs 154x74 h10mm



**MA1700**  
6 pcs 110x37 h10mm



**MA1806**  
8 pcs 119x29 h10mm



**MA1910**  
8 pcs 99x33 h10mm



**MA1911**  
8 pcs 103x29 h12,5mm



**MA1912**  
8 pcs 112x32,5 h15,5mm



**MA1913**  
8 pcs 119x29 h10mm



**MA2000**  
3 tav./ bars 150x70 h11mm



**MA2001**  
3 tav./ bars 160x75 h8mm



**MA2004**  
4 tav./ bars 130x55 h8mm



**MA2005**  
3 tav./ bars 159x80 h9mm

## STAMPI PROFESSIONALI SOGGETTI PROFESSIONAL MOULDS FOR SUBJECTS

Stampi professionali per realizzare simpatici soggetti e decorazioni di cioccolato. Lo stampo tazzina è ideale per produrre dessert monoporzione e mignon. Professional moulds to produce chocolate subjects and decorations. The cup mould is perfect to prepare monoportion and mignon dessert.

Cod.	Descr.	Misure - Size	cap.
<b>MA1951</b>	Tazzine grandi - Big cups	Ø59 h36 mm	7 pcs
<b>MA1952</b>	Piattini grandi - Big saucers	Ø91 mm	3 pcs
<b>MA1953</b>	Tazzine piccole - Small cups	Ø51 h32 mm	7 pcs
<b>MA1954</b>	Piattini piccoli - Small saucers	Ø80 mm	5 pcs



Cod.	Descr.	Misure - Size	cap.
<b>MA1950</b>	quadrante orologio - clock face	77x70 h10 mm	6 pcs

# STAMPI PROFESSIONALI PER DECORAZIONI PROFESSIONAL MOULDS FOR DECORATIONS



Nuova linea stampi professionali: design e qualità made in Italy.  
Progettati e realizzati con il preciso intento di fornire al pasticciere un valido strumento per produrre raffinate decorazioni di cioccolato.  
Decorazioni di grande effetto che concedono ampie possibilità di interpretazione al fine di donare un tocco di unicità al dessert.

**Per la linea stampi decorazioni è consigliabile l'uso di cioccolato più fluido.**

New Professional moulds line: made in Italy design and quality. Designed and produced to give pastry chefs a perfect tool to create fine chocolate decorations. Wonderful decorations to make your desserts unique.









**For our decoration moulds line we suggest to use a very fluid chocolate.**

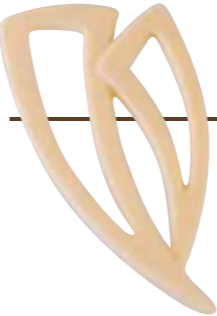
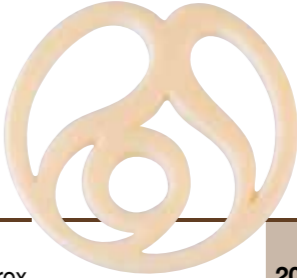

Nuovo materiale alta qualità.  
New high quality material.  
Misura - Size: 175x275mm

Cod.	Misure - Size	cap.	Gr.
20-D001	63x h21 mm	18 pcs	2/3 gr approx
20-D002	66x h20 mm	18 pcs	2/3 gr approx
20-D003	64x h26 mm	16 pcs	2/3 gr approx
20-D004	63x h23 mm	18 pcs	2/3 gr approx
20-D005	72x h24 mm	18 pcs	2/3 gr approx
20-D006	72x h19 mm	18 pcs	2/3 gr approx

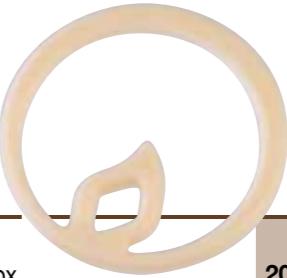

	<i>Cod.</i>	<i>Misure - Size</i>	<i>cap.</i>	<i>Gr.</i>		<i>Cod.</i>	<i>Misure - Size</i>	<i>cap.</i>	<i>Gr.</i>
	<b>20-D007</b>	66x h21 mm	18 pcs	2/3 gr approx		<b>20-D008</b>	65x h22 mm	18 pcs	2/3 gr approx
	<i>Cod.</i>	<i>Misure - Size</i>	<i>cap.</i>	<i>Gr.</i>		<i>Cod.</i>	<i>Misure - Size</i>	<i>cap.</i>	<i>Gr.</i>
	<b>20-D009</b>	70x h19 mm	18 pcs	2/3 gr approx		<b>20-D010</b>	50 x h38 mm	14 pcs	2/3 gr approx
	<i>Cod.</i>	<i>Misure - Size</i>	<i>cap.</i>	<i>Gr.</i>		<i>Cod.</i>	<i>Misure - Size</i>	<i>cap.</i>	<i>Gr.</i>
	<b>20-D011</b>	62 x h31 mm	16 pcs	2/3 gr approx		<b>20-D012</b>	50 x h49 mm	12 pcs	2/3 gr approx
	<i>Cod.</i>	<i>Misure - Size</i>	<i>cap.</i>	<i>Gr.</i>		<i>Cod.</i>	<i>Misure - Size</i>	<i>cap.</i>	<i>Gr.</i>
	<b>20-D013</b>	47 x h39 mm	15 pcs	2/3 gr approx		<b>20-D014</b>	Ø50 mm	11 pcs	2/3 gr approx
	<i>Cod.</i>	<i>Misure - Size</i>	<i>cap.</i>	<i>Gr.</i>		<i>Cod.</i>	<i>Misure - Size</i>	<i>cap.</i>	<i>Gr.</i>
	<b>20-D015</b>	129 x h17 mm	12 pcs	12 gr approx		<b>20-D016</b>	110 x h7 mm	22 pcs	3/4 gr approx

STAMPI PROFESSIONALI PER DECORAZIONI  
PROFESSIONAL MOULDS FOR DECORATIONS







Cod.	Misure - Size	cap.	Gr.
<b>MA3000</b>	40x h106 mm	6 pcs	8 gr approx



Cod.	Misure - Size	cap.	Gr.
<b>MA3001</b>	39x h104 mm	6 pcs	8 gr approx



Cod.	Misure - Size	cap.	Gr.
<b>MA3002</b>	56x h83 mm	6 pcs	8 gr approx



Cod.	Misure - Size	cap.	Gr.
<b>MA3003</b>	70x h57 mm	6 pcs	8 gr approx



Cod.	Misure - Size	cap.	Gr.
<b>MA3004</b>	72x h71 mm	6 pcs	8 gr approx



# STAMPI PROFESSIONALI 3D 3D PROFESSIONAL MOULDS



La collezione 3D è composta da 10 stampi ideati per la produzione di praline di cioccolato tridimensionali. Lo stampo, è composto da tre parti. La base ed il coperchio, che definiscono la forma della pralina 3D, sono entrambe dotate di calamite, rendendo così possibile una resistente unione. Il terzo componente consiste invece in una placca forata necessaria per una pratica e veloce lisciatura dopo lo svuotamento del cioccolato in eccesso.

Our 3D collection consists of 10 moulds to produce three-dimensional chocolate pralines. Our moulds are composed of three parts. The base and the lid, which define the shape of 3D pralines, are both equipped with magnets, for a strong union. The third component is a little perforated plate, necessary for a practical and fast smoothing after draining the excess chocolate.

- 1- Unire le due parti di stampo;
- 2- Riempire gli alveoli di cioccolato con l'aiuto di una sac a poche;
- 3- Inserire la placca forata;
- 4- Svuotare il cioccolato nella Meltingchoc per creare la camicia della pralina;
- 5- Con l'aiuto di una spatola lisciare per togliere il cioccolato in eccesso;
- 6- Staccare la placca forata prima che il cioccolato cristallizzi;
- 7- Aprire lo stampo per estrarre le praline.

- 1- Combine the two parts of the mould;
- 2- Fill the alveoli with chocolate using a pastry bag;
- 3- Insert the perforated plate;
- 4- Empty the chocolate into the Meltingchoc to create the outer layer of the praline;
- 5- With the help of a spatula remove the chocolate in excess;
- 6- Remove the perforated plate before the chocolate crystallizes;
- 7- Open the mould to remove the pralines.

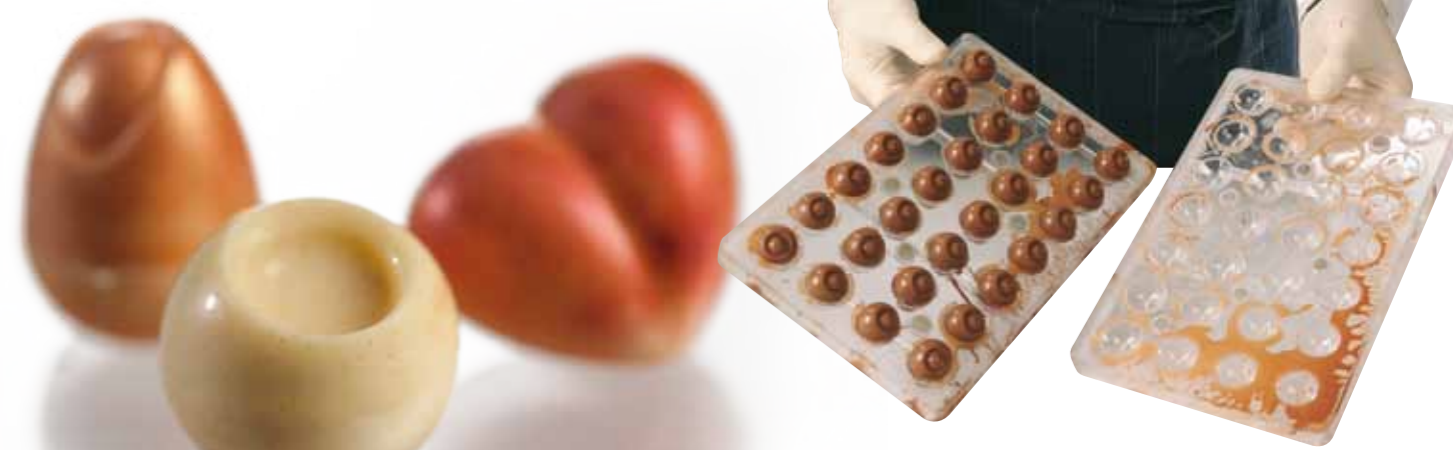
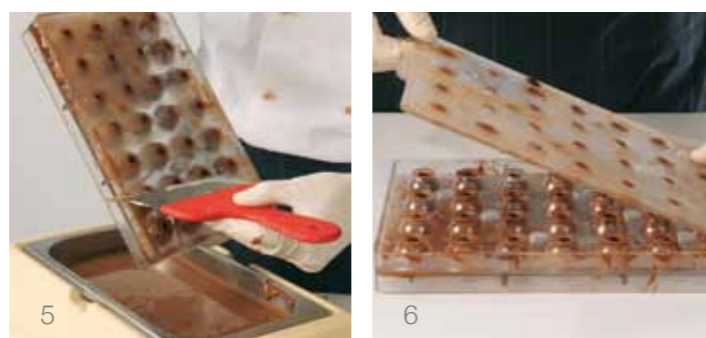
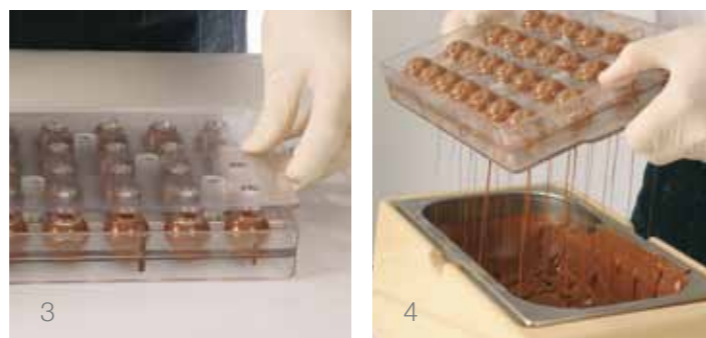

Cod.	Misure - Size	cap.	Gr.
<b>20-3D1001</b>	23x30 h 23	28 pcs	8 gr approx
<b>20-3D1002</b>	23x32 h 23	28 pcs	8 gr approx

Cod.	Misure - Size	cap.	Gr.
<b>20-3D1003</b>	23x30 h 23	28 pcs	8 gr approx
<b>20-3D2001</b>	26x26 h 26	28 pcs	8 gr approx

Cod.	Misure - Size	cap.	Gr.
<b>20-3D2002</b>	26x26 h 26	28 pcs	8 gr approx
<b>20-3D2003</b>	26x26 h 26	28 pcs	8 gr approx

Cod.	Misure - Size	cap.	Gr.
<b>20-3D3001</b>	26x26 h 26	28 pcs	8 gr approx
<b>20-3D4001</b>	28x24 h 24	28 pcs	8 gr approx

Cod.	Misure - Size	cap.	Gr.
<b>20-3D5001</b>	31x27 h 21	28 pcs	8 gr approx
<b>20-3D6001</b>	32x18 h 28	28 pcs	8 gr approx

# STAMPI PROFESSIONALI 3D CON CALAMITE 3D PROFESSIONAL MAGNETIC MOULDS



**3D**

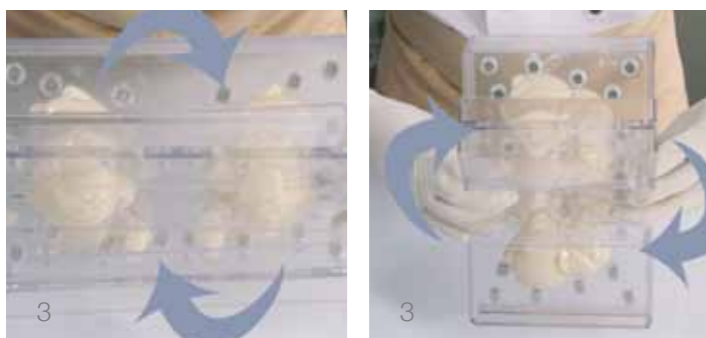
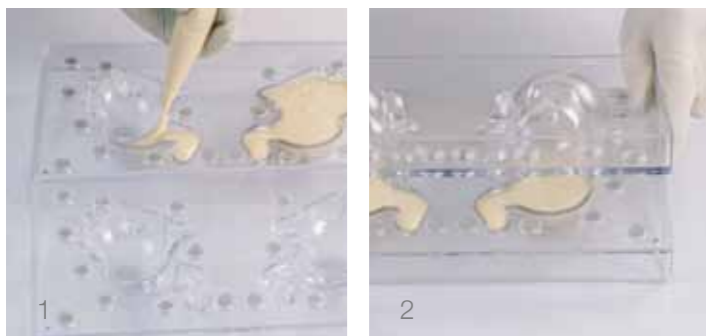

1 - Riempire mezzo guscio utilizzando una sac a pochés.  
2 - Chiudere avendo cura di posizionare correttamente l'altra metà dello stampo.  
3 - Far ruotare ripetutamente lo stampo affinché il cioccolato aderisca alle pareti in modo uniforme.  
4 - Sformare il soggetto avendo cura di aprire i due gusci con delicatezza.

1 - Close the mould paying attention to combine correctly the two halves.  
2 - Fill one half of the mould using a pastry bag.  
3 - Rotate the mould (in all directions) for some time, so that the chocolate spreads all over the internal surface.  
4 - Remove gently the two halves of the mould.



Albero  
Tree



Cod.	Misure - Size	cap.	Gr
20-C1000	Ø58 h100 mm	5 pcs	70 gr

Renna  
Reindeer



Cod.	Misure - Size	cap.	Gr
20-C1001	43x43x h120 mm	4 pcs	65 gr

Renna  
Reindeer



Cod.	Misure - Size	cap.	Gr
20-C1002	46x45x h100 mm	4 pcs	68 gr

Scoiattolo Papà  
Dad Squirrel



Cod.	Misure - Size	cap.	Gr
20-C1003	92x51 h120 mm	2 pcs	118 gr

Scoiattolo Mamma  
Mum Squirrel



Cod.	Misure - Size	cap.	Gr
20-C1004	103x40 h80 mm	4 pcs	55 gr

Scoiattolo Bebè  
Baby Squirrel

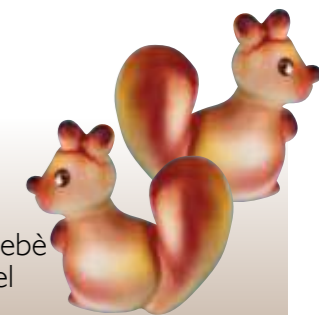

Cod.	Misure - Size	cap.	Gr
20-C1005	68x32 h64 mm	6 pcs	32 gr

Elefante Papà  
Dad Elephant



Cod.	Misure - Size	cap.	Gr
20-C1006	123x64 h81 mm	2 pcs	128 gr

Elefante Mamma  
Mum Elephant



Cod.	Misure - Size	cap.	Gr
20-C1007	113x62 h62 mm	4 pcs	87 gr

Elefante Bebè  
Baby Elephant



Cod.	Misure - Size	cap.	Gr
20-C1008	81x43 h56 mm	6 pcs	36 gr

Gallo  
Rooster



Cod.	Misure - Size	cap.	Gr
20-C1955	100x160 h126 mm	2 pcs	115 gr

Gallina  
Hen



Cod.	Misure - Size	cap.	Gr
20-C1956	94x108 h106 mm	4 pcs	75 gr
*MA1956	94x108 h106 mm	4 pcs	75 gr

Pulcino  
Chick



Cod.	Misure - Size	cap.	Gr
20-C1957	65x84 h80 mm	6 pcs	45 gr
*MA1957	65x84 h80 mm	6 pcs	45 gr

\* STAMPI MEZZO GUSCIO - HALF SHELL MOULDS

# STAMPI 3D CORPO CAVO HOLLOW 3D MOULDS

Stampi in plastica corpo cavo per soggetti di cioccolato pasquali, disponibili varie forme e dimensioni.  
Plastic moulds, hollow forms for Easter chocolate subjects, different shapes and sizes available.



Legenda - Legend

<b>STAMPO A 1 FORMA</b> <b>1 SUBJECT MOULD</b>	#1	
<b>STAMPO A 2 FORME</b> <b>2 SUBJECTS MOULD</b>	#2	
<b>STAMPO A 3 FORME</b> <b>3 SUBJECTS MOULD</b>	#3	



	Cod.	Misure - Size	#
	<b>MAC600</b>	h 200 mm	#1

	Cod.	Misure - Size	#
	<b>MAC601</b>	h 200 mm	#1

	Cod.	Misure - Size	#
	<b>MAC610S</b>	h 170 mm	#1

	Cod.	Misure - Size	#
	<b>MAC620</b>	h 180 mm	#1

	Cod.	Misure - Size	#
	<b>MAC630</b>	h 235 mm	#1

	Cod.	Misure - Size	#
	<b>MAC640</b>	h 185 mm	#1

	Cod.	Misure - Size	#
	<b>MAC650</b>	h 145mm	#2

	Cod.	Misure - Size	#
	<b>MAC660</b>	h 110 mm	#1
	<b>MAC661S</b>	h 140 mm	#1
	<b>MAC662</b>	h 190 mm	#1

	Cod.	Misure - Size	#
	<b>MAC670</b>	h 195 mm	#1

	Cod.	Misure - Size	#
	<b>MAC690</b>	h 215 mm	#1
	<b>MAC691</b>	h320 mm	#1

	Cod.	Misure - Size	#
	<b>MAC720S</b>	h 170 mm	#2
	<b>MAC721</b>	h 220 mm	#1
	<b>MAC722</b>	h 360 mm	#1

	Cod.	Misure - Size	#
	<b>MAC740</b>	h 220 mm	#1

	Cod.	Misure - Size	#
	<b>MAC760</b>	h 150 mm	#1

	Cod.	Misure - Size	#
	<b>MAC800S</b>	h 160 mm	#2
	<b>MAC801</b>	h 205 mm	#1
	<b>MAC802</b>	h 65 mm	#3

	Cod.	Misure - Size	#
	<b>MAC683</b>	h 130 mm	#4
	<b>MAC686</b>	h 275 mm	#1
	<b>MAC687</b>	h 360 mm	#1

	Cod.	Misure - Size	#
	<b>MAC710</b>	h 225 mm	#1

	Cod.	Misure - Size	#
	<b>MAC730</b>	h 480 mm	#1

	Cod.	Misure - Size	#
	<b>MAC750</b>	h 110 mm	#3

	Cod.	Misure - Size	#
	<b>MAC770</b>	h 110 mm	#3

	Cod.	Misure - Size	#
	<b>MAC810</b>	h 60 mm	#3





Cod.	Misure - Size	#
MAC820	h 55 mm	#4
MAC821	h 85 mm	#4
MAC822	h 110 mm	#1
MAC823S	h 160 mm	#1
MAC824	h 200 mm	#1



Cod.	Misure - Size	#
MAC832	h 175 mm	#1



Cod.	Misure - Size	#
MAC840	h 170 mm	#1
MAC841	h 265 mm	#1



Cod.	Misure - Size	#
MAC850S	h 125 mm	#2



Cod.	Misure - Size	#
MAC860S	h 125 mm	#2



Cod.	Misure - Size	#
MAC870S	h 110 mm	#3



Cod.	Misure - Size	#
MAC880S	h 145 mm	#1



Cod.	Misure - Size	#
MAC900	h 110 mm	#1
MAC901	h 175 mm	#1



Cod.	Misure - Size	#
MAC910	h 40 mm	#1
MAC913	h 55 mm	#1
MAC915	h 65 mm	#1



Cod.	Misure - Size	#
MAC920S	h 97 mm	#2



Cod.	Misure - Size	#
MAC950	h 110 mm	#1
MAC951	h 115 mm	#1
MAC952S	h 140 mm	#1
MAC953	h 150 mm	#1
MAC954	h 190 mm	#1



STAMPI 3D CORPO CAVO  
HOLLOW 3D MOULDS



Cod.	Misure - Size	#
MAC000	h 80 mm	#3
MAC001	h 125 mm	#2
MAC002S	h 175 mm	#1



Cod.	Misure - Size	#
MAC020	h 95 mm	#3



Cod.	Misure - Size	#
MAC110	h 204 mm	#1



Cod.	Misure - Size	#
MAC130	h 122 mm	#3
MAC131	h 157 mm	#2



Cod.	Misure - Size	#
MAC120	h 110 mm	#4
MAC122	h 140 mm	#4
MAC123	h 190 mm	#2
MAC124	h 260 mm	#1
MAC125	h 320 mm	#1



Cod.	Misure - Size	#
MAC140	h 180 mm	#1



Cod.	Misure - Size	#
<b>MAC150</b>	h 140 mm	#1
<b>MAC151</b>	h 220 mm	#1



Cod.	Misure - Size	#
<b>MAC161</b>	h 110 mm	#3
<b>MAC162</b>	h 140 mm	#1
<b>MAC163</b>	h 220 mm	#1
<b>MAC164</b>	h 310 mm	#1



Cod.	Misure - Size	#
<b>MAC281S</b>	h 180 mm	#1



Cod.	Misure - Size	#
<b>MAC300</b>	h 230 mm	#1



Cod.	Misure - Size	#
<b>MAC170S</b>	h 168 mm	#1



Cod.	Misure - Size	#
<b>MAC180</b>	h 145 mm	#1



Cod.	Misure - Size	#
<b>MAC310</b>	h 100 mm	#2



Cod.	Misure - Size	#
<b>MAC311</b>	h 165 mm	#1



Cod.	Misure - Size	#
<b>MAC190</b>	h 170 mm	#1



Cod.	Misure - Size	#
<b>MAC200</b>	h 120 mm	#1



Cod.	Misure - Size	#
<b>MAC320</b>	h 114 mm	#3
<b>MAC321</b>	h 150 mm	#1



Cod.	Misure - Size	#
<b>MAC410S</b>	h 192 mm	#1



Cod.	Misure - Size	#
<b>MAC230</b>	h 95 mm	#1



Cod.	Misure - Size	#
<b>MAC240S</b>	h 185 mm	#1



Cod.	Misure - Size	#
<b>MAC260</b>	h 95 mm	#4
<b>MAC261</b>	h 245 mm	#1



Cod.	Misure - Size	#
<b>MAC270</b>	h 140 mm	#1
<b>MAC271</b>	h 200 mm	#1



Cod.	Misure - Size	#
<b>MAC220</b>	h 475 mm	#1



Cod.	Misure - Size	#
<b>MAC400</b>	h 415 mm	#1



Cod.	Misure - Size	#
MAC421S	h 135 mm	#1
MAC420	h 125 mm	#1



Cod.	Misure - Size	#
MAC440	h 150 mm	#1
MAC441	h 205 mm	#1



Cod.	Misure - Size	#
MAC500	h 110 mm	#3
MAC501	h 140 mm	#2
MAC502	h 170 mm	#2
MAC503	h 240 mm	#1
MAC504	h 320 mm	#1



Cod.	Misure - Size	#
MAC510	h 110 mm	#3
MAC511	h 140 mm	#2
MAC513	h 235 mm	#1



Cod.	Misure - Size	#
MAC521	h 180 mm	#1
MAC522	h 220 mm	#1
MAC523	h 255 mm	#1



Cod.	Misure - Size	#
MAC326S	220x75 h 170	#1

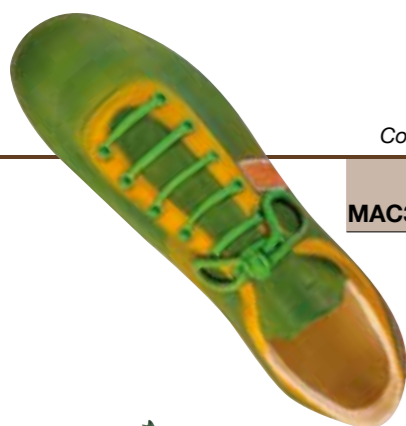

Cod.	Misure - Size	#
MAC322S	195x60h80	#1



Cod.	Misure - Size	#
MAC323S	Ø120	#1



Cod.	Misure - Size	#
MAC324S	95x90 h110	#1



Cod.	Misure - Size	#
MAC325S	140x140 h150	#1

## KIT SCENETTE DI PASQUA - EASTER LANDSCAPE KIT

Kit composto da 3 diverse scenette.  
Kit made up of 3 different landscapes.



Cod.	Misure - Size
20-S2010	h110mm



## KIT SCENETTE DI NATALE - CHRISTMAS LANDSCAPE KIT

Kit composto da 3 diverse scenette.  
Kit made up of 3 different landscapes.



Cod.	Misure - Size
20-S1010	h110mm



## STAMPO CUCCHIAINO TRIDIMENSIONALE 3D SPOON MOULD



Cod.	Misure - Size
<b>SCC01</b>	25x95mm

## TAVOLETTE CIOCCOLATO CHOCOLATE BARS



Cod.	Misure - Size	Pack
<b>TC001/5</b>	150x70mm	5 pcs
<b>TC002/5</b>	150x70mm	5 pcs
<b>TC003/5</b>	150x70mm	5 pcs



## ESPOSITORI IN PLEXIGLASS TAVOLETTE DI CIOCCOLATO PLEXIGLASS DISPLAYS FOR CHOCOLATE BARS



Cod.	Misure - Size
<b>ET001</b>	297x295 h400 mm



Cod.	Misure - Size
<b>ET003</b>	310x200 h400 mm



Cod.	Misure - Size
<b>ET004</b>	245x300 h290 mm



Cod.	Misure - Size
<b>ET004B</b>	315x410 h370 mm



Cod.	Misure - Size
<b>ET006</b>	305x190 h470 mm

## KIT STAMPI FIORE DI LOTO LOTUS MOULDS KIT

Kit composto da: 1 stampo semisfera e 4 stampi petalo.  
Kit made up of 1 semisphere mould and 4 petal moulds.

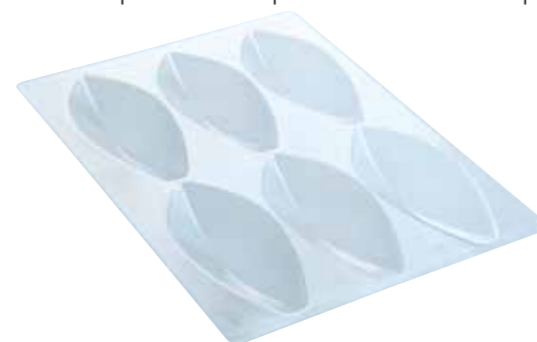

Cod.	Base	Petali - Petal	Produttività - Productivity
<b>20-1010</b>	Ø75 mm	105x50 h25mm	6 petali/stampo - 6 petals for moulds
<b>20-1011</b>	Ø75 mm	80x35 h18mm	8 petali/stampo - 8 petals for moulds



## KIT STAMPI SFERE SPHERE MOULDS KIT

Stampi sfera in PETG.  
Made of PETG sphere moulds.



Cod.	Misure - Size
<b>MACS001</b>	Ø30 - Ø24,5 cm
<b>MACS002</b>	Ø20 - Ø17,5 - Ø15 - Ø14 - Ø13 - Ø10 cm
<b>MACS003</b>	4x Ø9 - 4x Ø7,5 - 4x Ø6,5 - 6x Ø5 cm

## DECORAZIONI PER CUPCAKE CUPCAKE DECORATIONS

Decorazione per Cupcake Pallone da Calcio  
Cupcake Decorations Soccer Ball



Cod.	Misure - Size
<b>20-CA100</b>	Ø65 h 23mm



## KIT STAMPI CORNICI - FRAME MOULDS KIT

Stampi in plastica per cornici di cioccolato. Plastic moulds for chocolate frames.



Cod.	Misure - Size
<b>MACC001</b>	17,5x14,5 h2 - 21,5x16,5 h2 cm



Cod.	Misure - Size
<b>MACC002</b>	23x18,5 h1,5 - 23x18,5 h1,5 cm

## STAMPI IN POLIETILENE - POLYETHYLENE MOULDS

Stampi in polietilene per realizzare praline. Moltissimi soggetti per tutte le occasioni.  
Polyethylene moulds for the production of pralines. Many subjects for every occasion.



Legenda - vedi listino prezzi  
Legend - see price list

- Stampi piccoli  
Small moulds
- Stampi standard  
Standard moulds
- Stampi grandi  
Big moulds

## STAMPI IN POLIETILENE - SAN VALENTINO POLYETHYLENE MOULDS - ST. VALENTINE

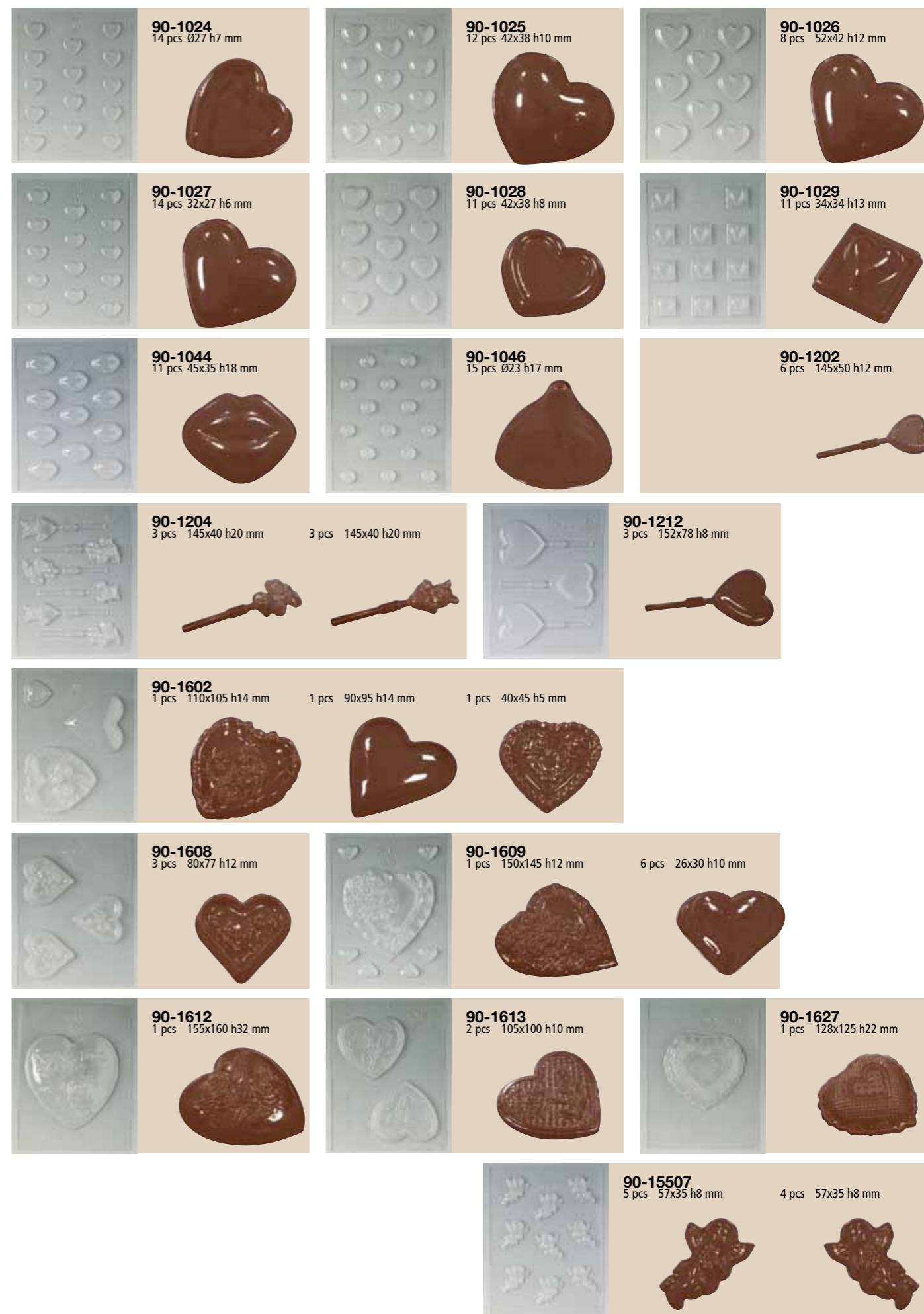
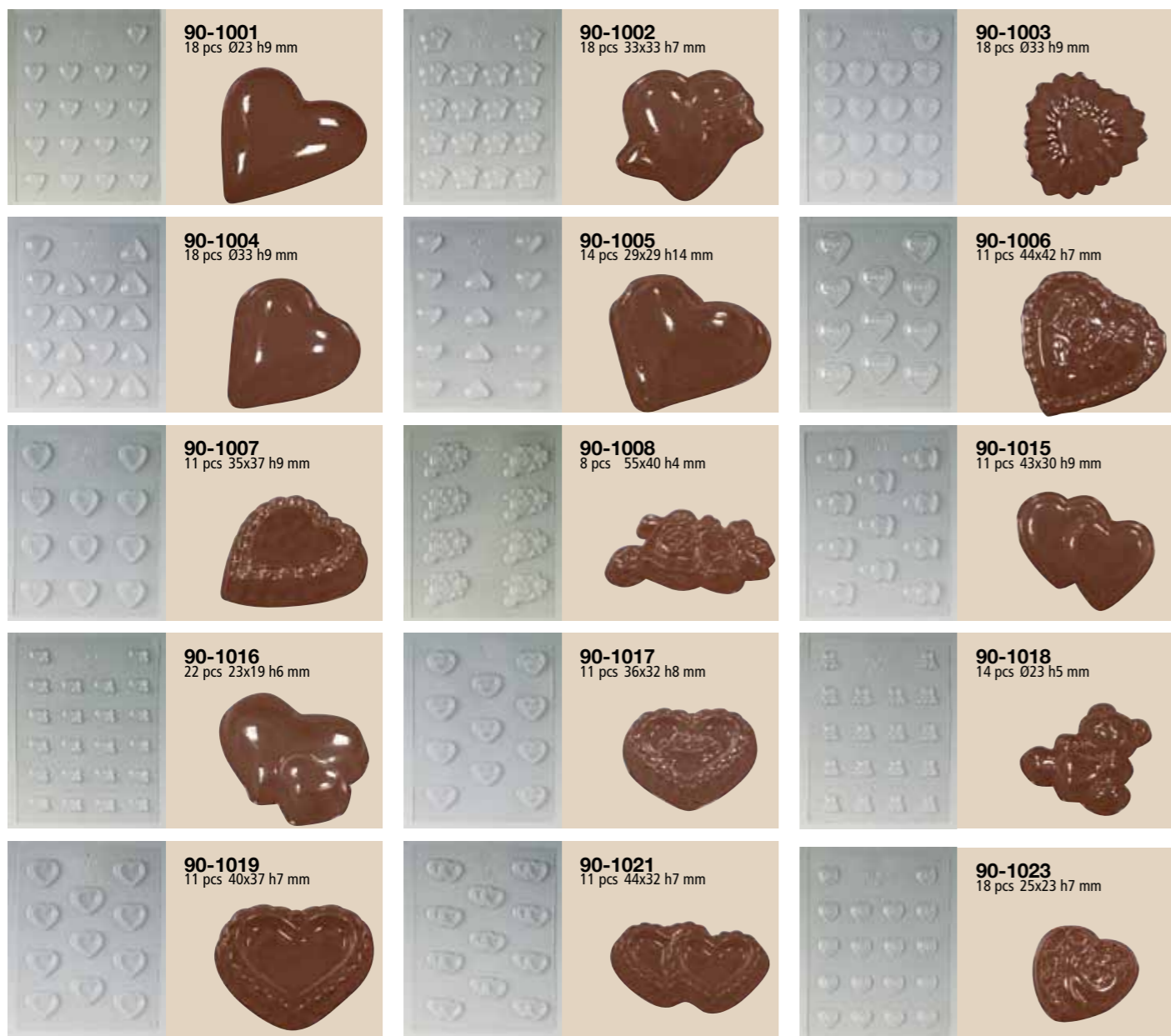

## STAMPI IN POLIETILENE - HALLOWEEN POLYETHYLENE MOULDS - HALLOWEEN



## STAMPI IN POLIETILENE - PASQUA POLYETHYLENE MOULDS - EASTER

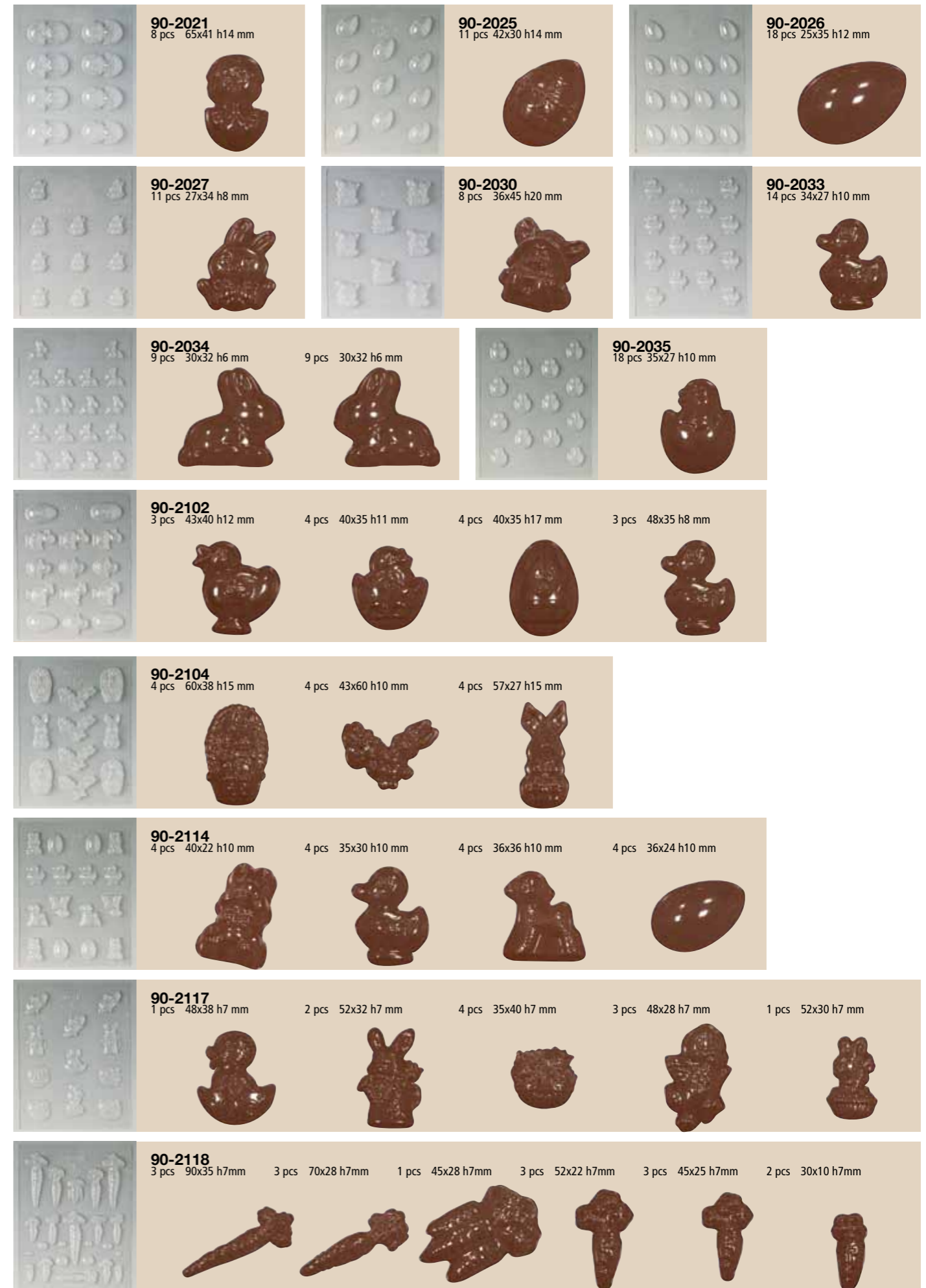
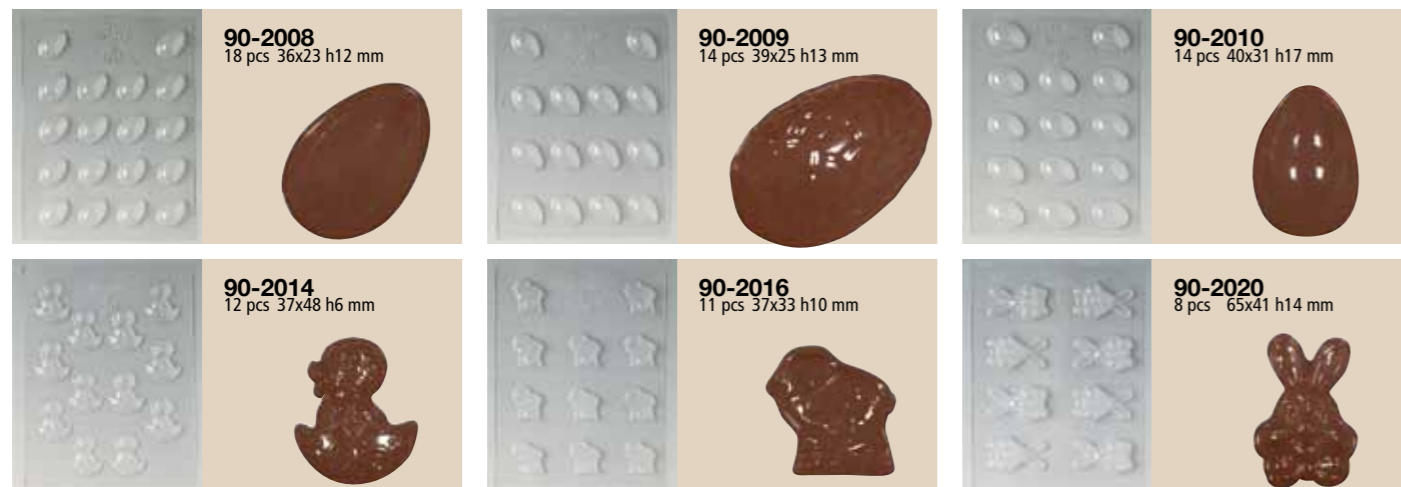

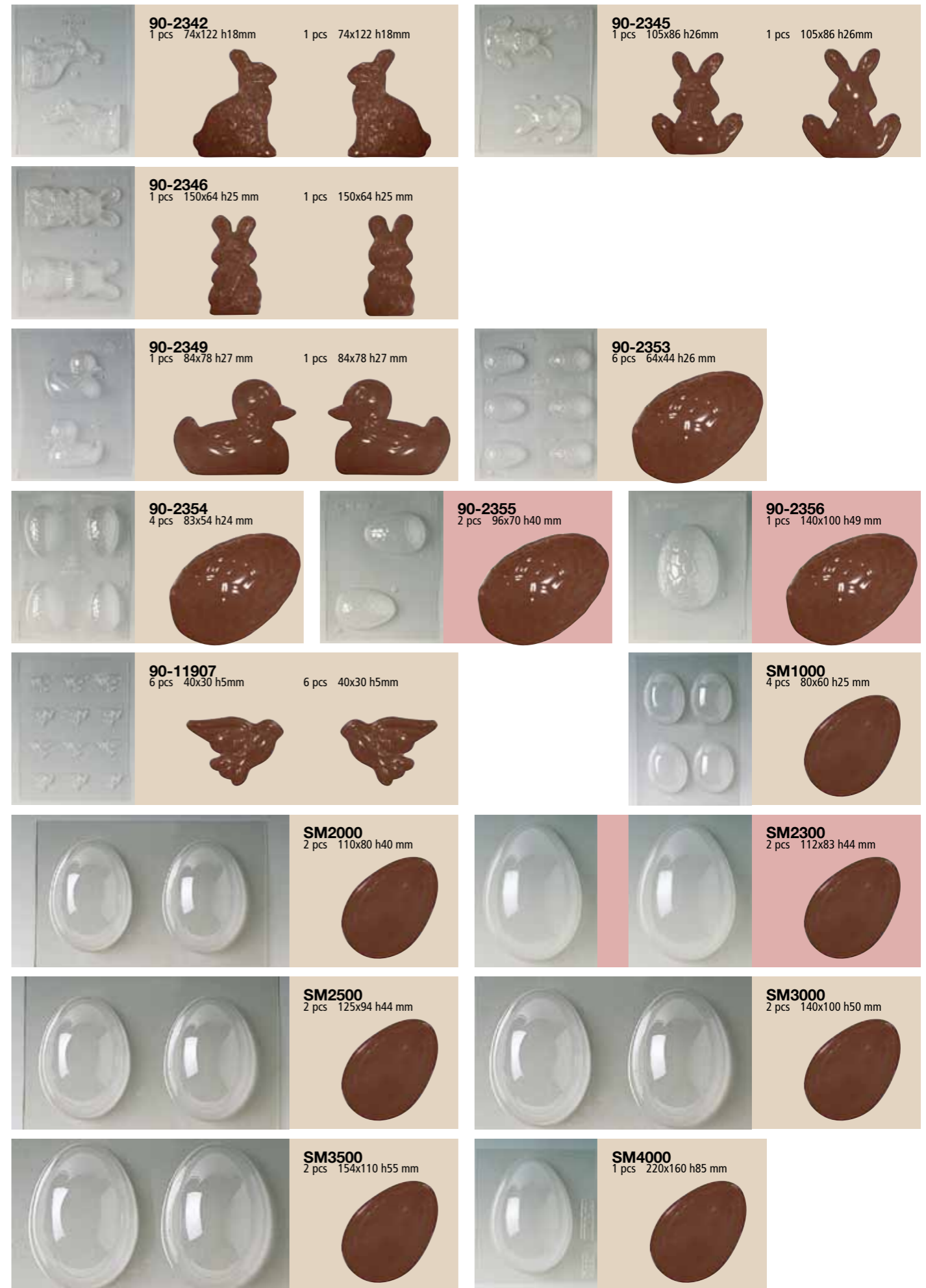
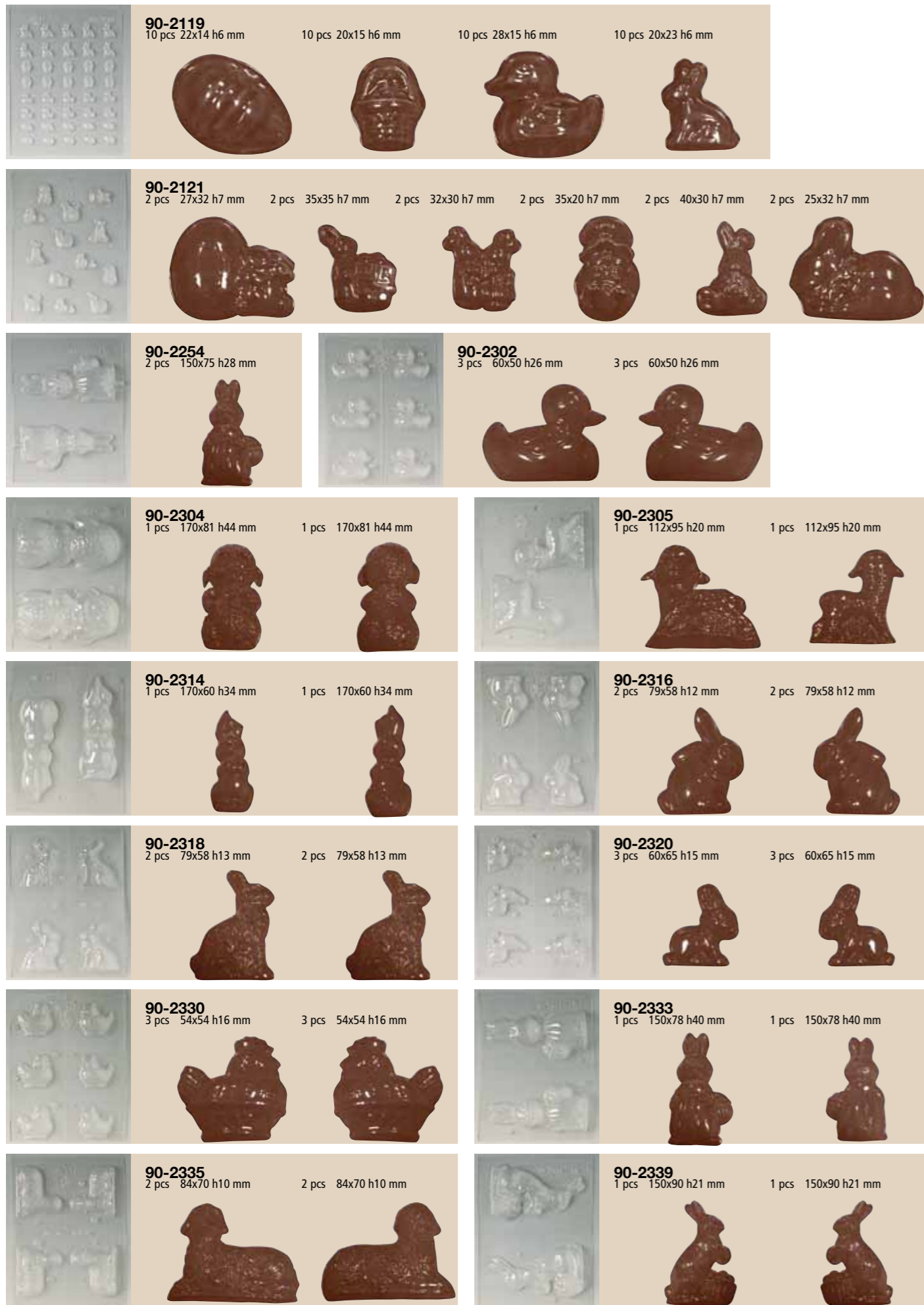

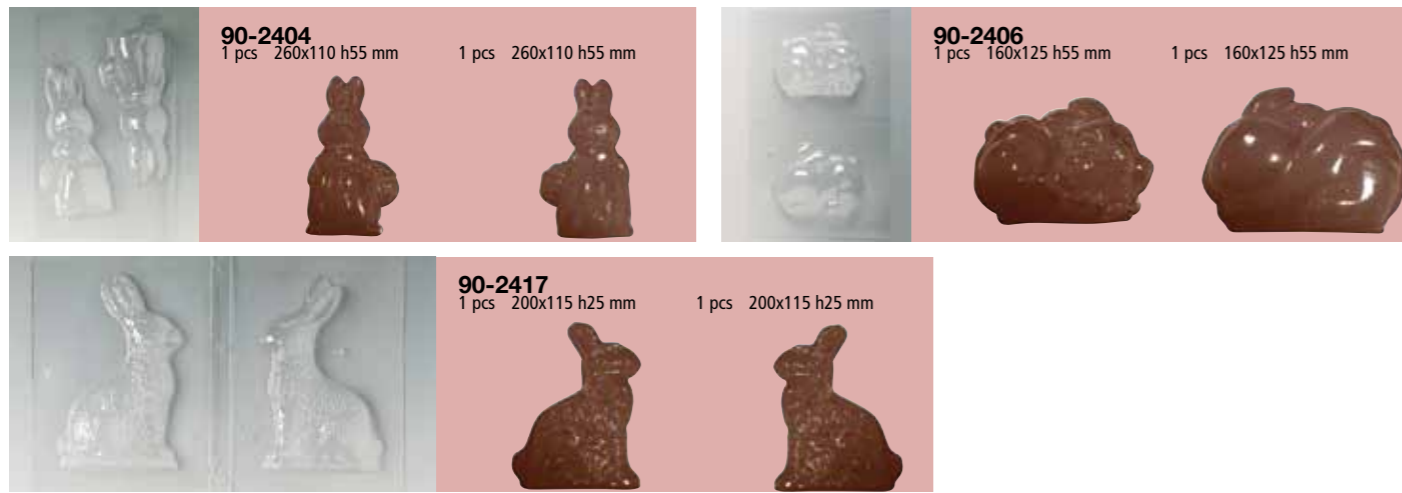

STAMPI IN POLIETILENE - NATALE  
POLYETHYLENE MOULDS - CHRISTMAS

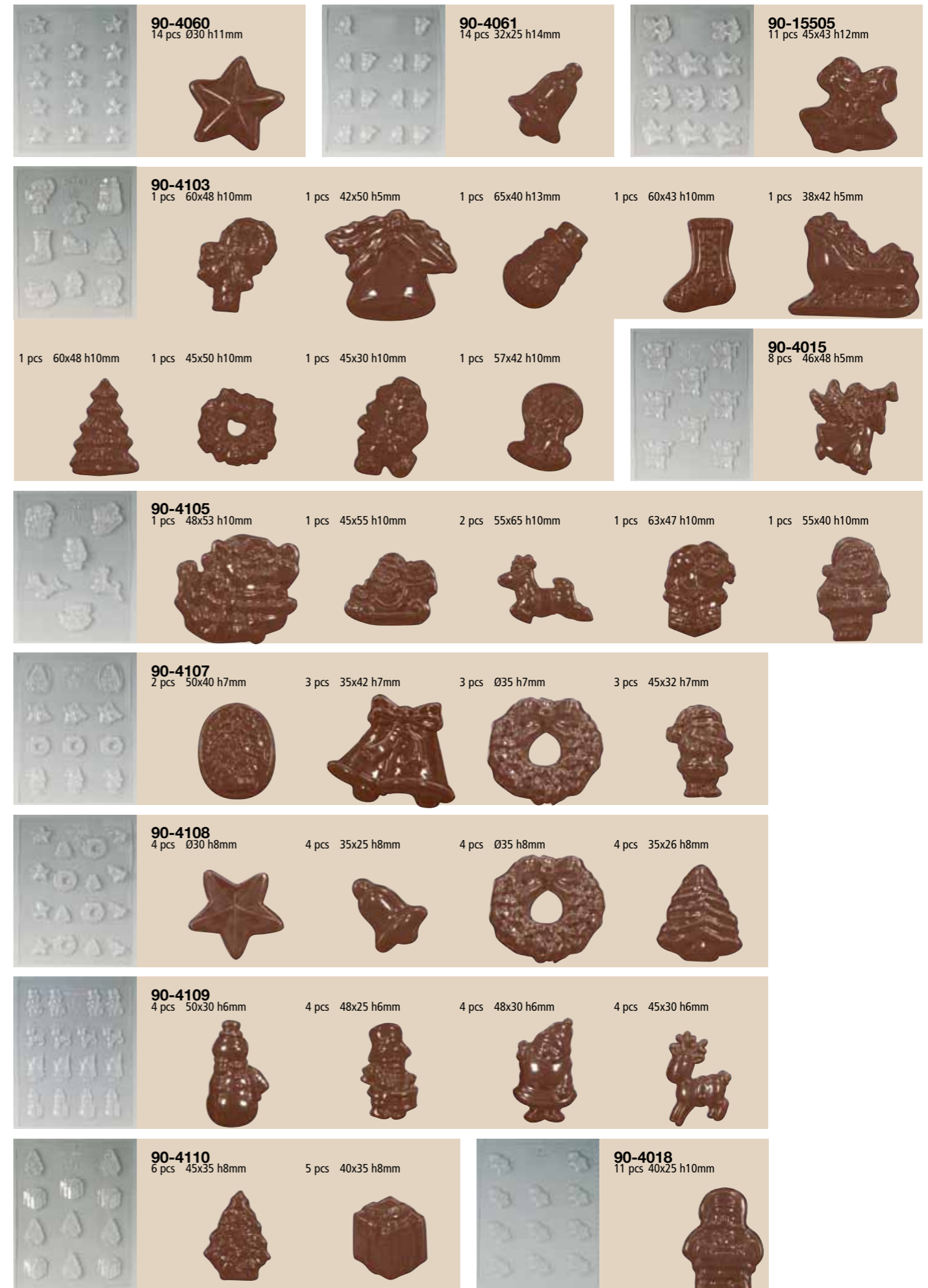
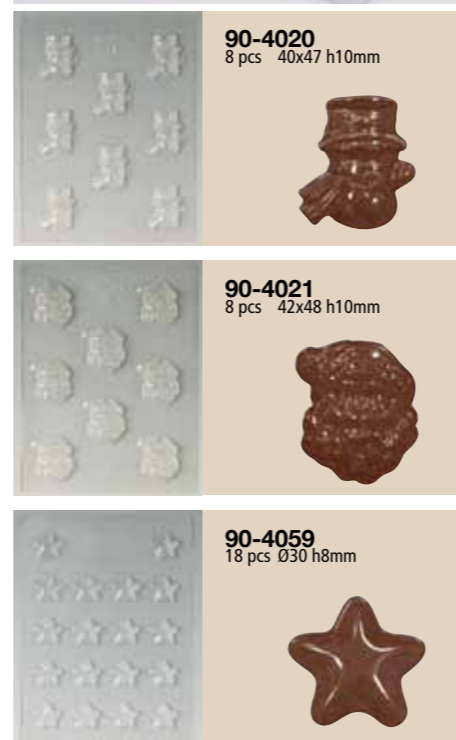
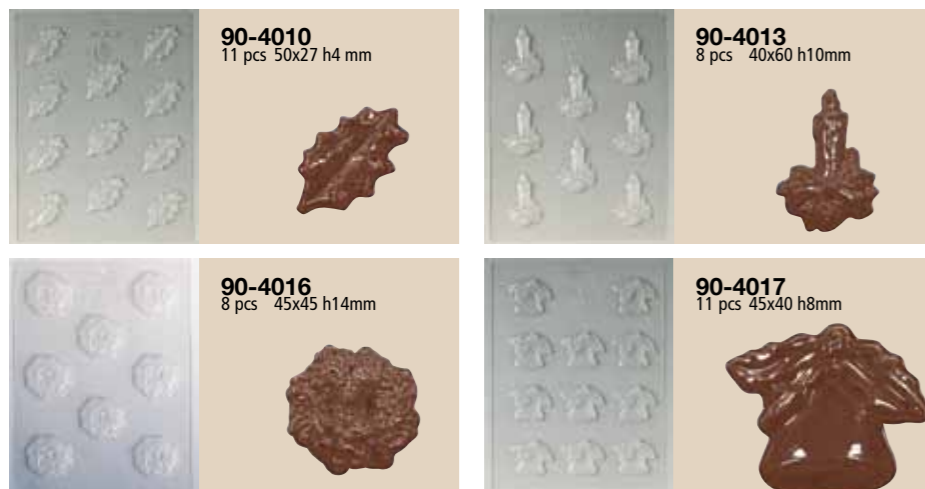





STAMPI IN POLIETILENE - PRALINERIA  
POLYETHYLENE MOULDS - PRALINES

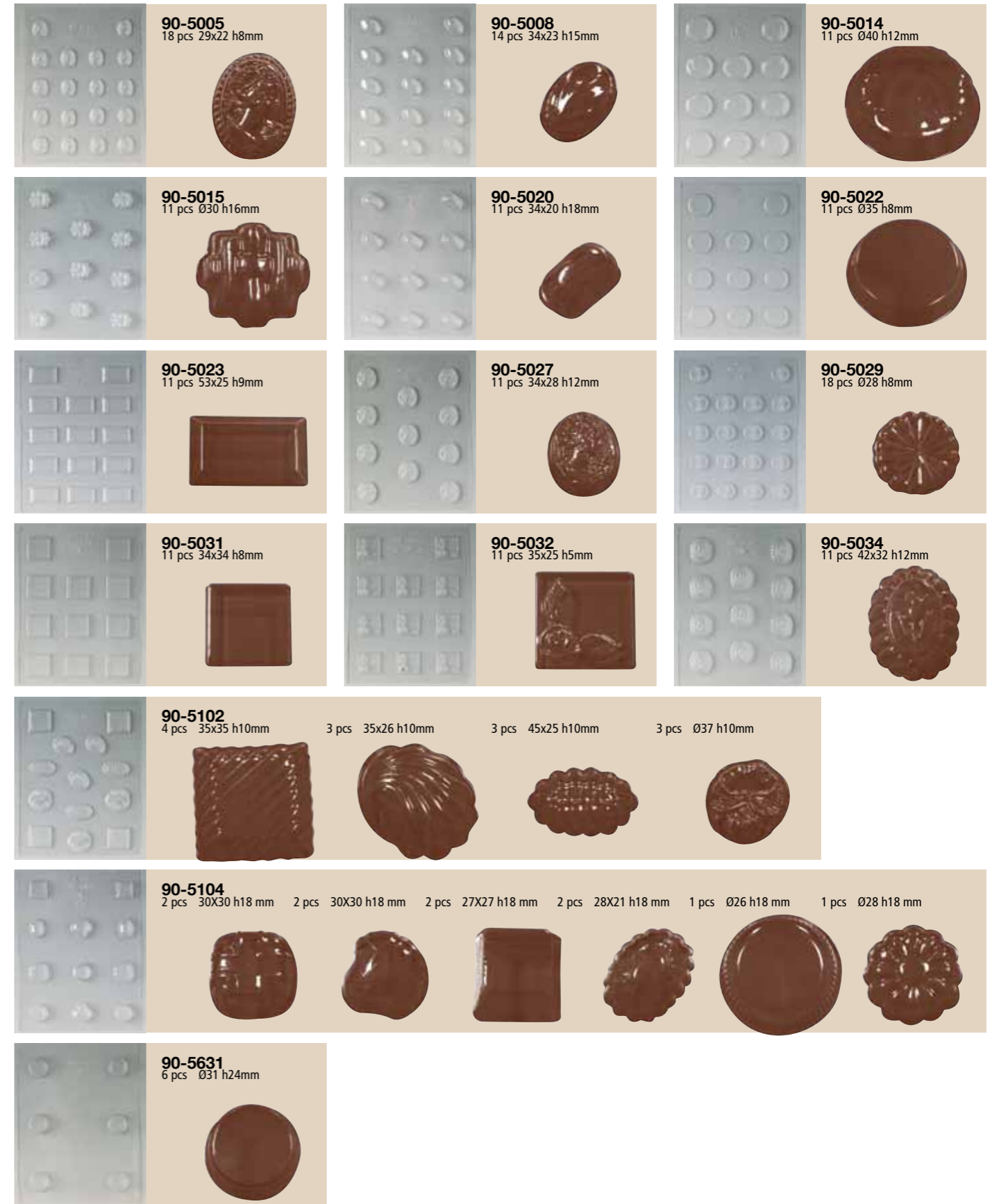

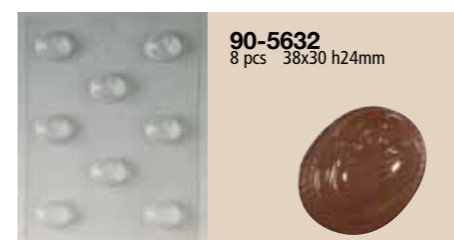
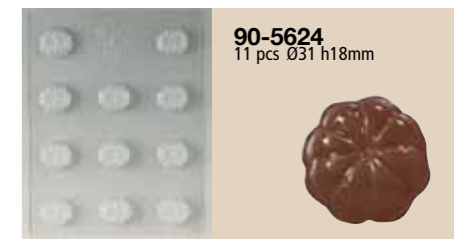
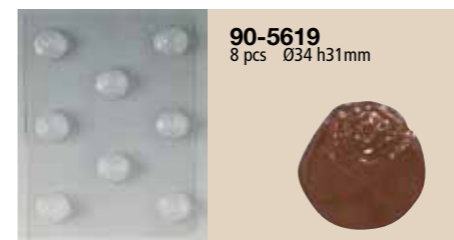
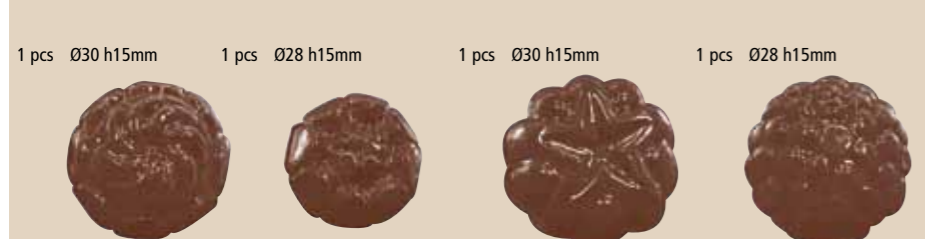
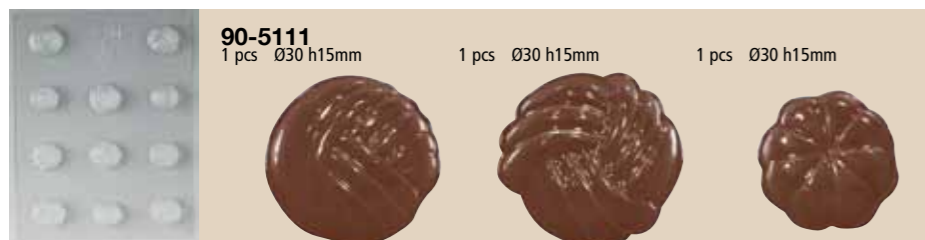
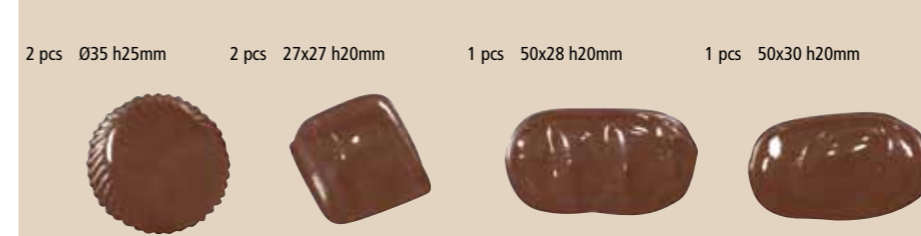
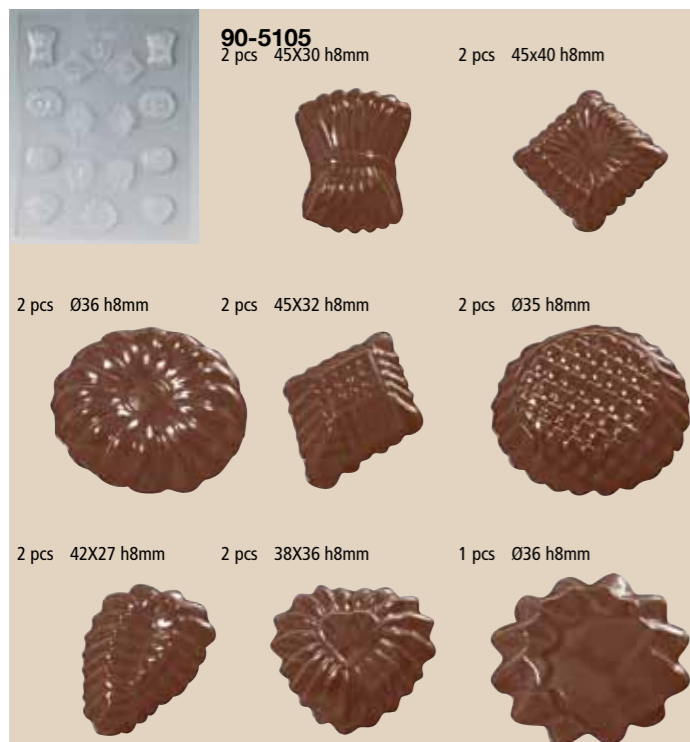

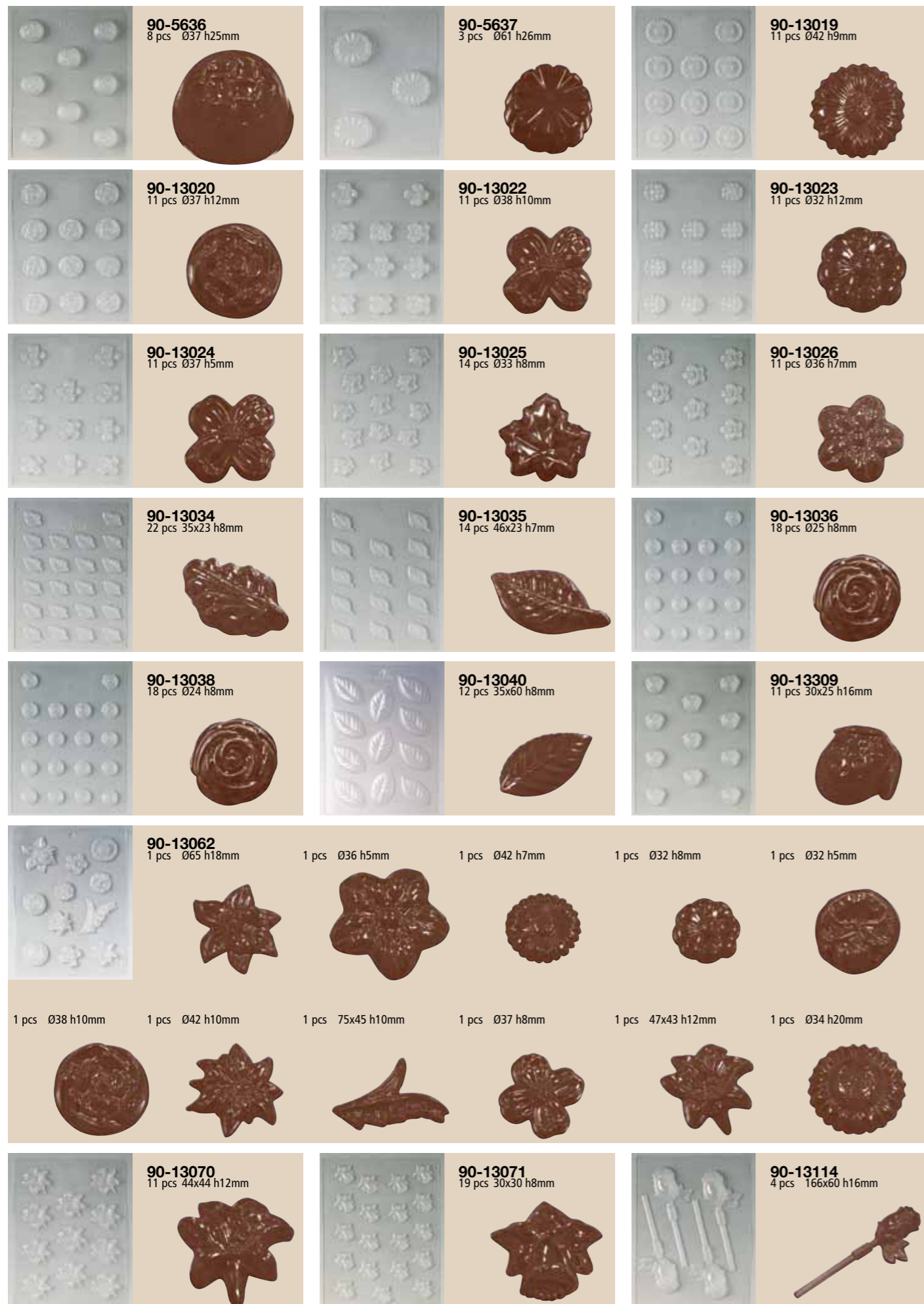

# STAMPI IN POLIETILENE - SPORT E MESTIERI POLYETHYLENE MOULDS - SPORT & JOBS

 <b>90-9991</b> 4 pcs 160x40 h20mm	 <b>90-6003</b> 14 pcs 39x25 h15mm	 <b>90-6008</b> 10 pcs Ø36 h20mm
 <b>90-6009</b> 8 pcs Ø42 h27mm	 <b>90-6012</b> 8 pcs 35x48 h17mm	 <b>90-6013</b> 11 pcs 44x24 h5mm
 <b>90-6302</b> 2 pcs Ø72 h35mm	 <b>90-6303</b> 3 pcs 68x43 h18mm    3 pcs 68x43 h18mm	
 <b>90-6401</b> 1 pcs 140x90 h44 mm    1 pcs 140x90 h44 mm		 <b>90-9653</b> 2 pcs 80x66 h14mm
 <b>90-6604</b> 1 pcs 80x80 h14mm    2 pcs 200x18 h10mm	 <b>90-6607</b> 1 pcs 145x106 h12mm	
 <b>90-6804</b> 2 pcs 90x52 h15 mm    1 pcs 50x75 h4mm    1 pcs 45x35 h25 mm	 <b>90-1000</b> 1 pcs 210x64 mm	
 <b>90-12682</b> 1 pcs 95x50 h8 mm    1 pcs 100x40 h8 mm    1 pcs 113x42 h8 mm    1 pcs 132x40 h8 mm    1 pcs 90x23 h8 mm    1 pcs 67x42 h8 mm		

 <b>90-13414</b> 4 pcs 30x30 h4mm	 4 pcs 28x28 h4mm	 4 pcs 30x22 h4mm	 4 pcs 30x27 h4mm
 <b>90-13452</b> 2 pcs 60x35 h18 mm	 2 pcs 53x35 h18 mm	 2 pcs 35x22 h10 mm	
 1 pcs 53x30 h15 mm	 1 pcs 53x30 h15 mm	 2 pcs 45x30 h14 mm	 2 pcs 50x30 h14 mm
 <b>90-13453</b> 2 pcs 85x40 h15 mm		 2 pcs 75x40 h15 mm	 2 pcs 60x32 h15 mm
 1 pcs 55x35 h15 mm	 1 pcs 55x35 h15 mm	 2 pcs 50x30 h15 mm	 2 pcs 40x30 h10 mm
 <b>90-13782</b> 2 pcs 95x40 h8 mm		 2 pcs 32x22 h10mm	 2 pcs 28x25 h10 mm
 <b>90-13477</b> 1 pcs 99x57 h5mm    1 pcs 99x57 h5mm    1 pcs 99x57 h5mm    1 pcs 99x57 h5mm			
 <b>90-13912</b> 2 pcs 60x25 h8 mm		 2 pcs 50x50 h8 mm	 2 pcs 40x7 h2 mm
 <b>90-15304</b> 8 pcs 45x46 h14mm			
 2 pcs 55x20 h8 mm	 1 pcs 75x30 h8 mm	 2 pcs 82x35 h8 mm	 2 pcs 75x30 h8 mm

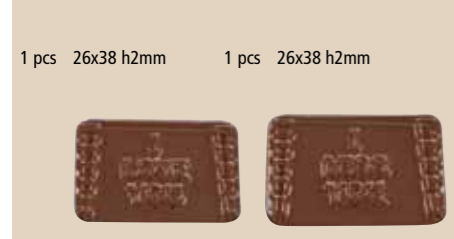
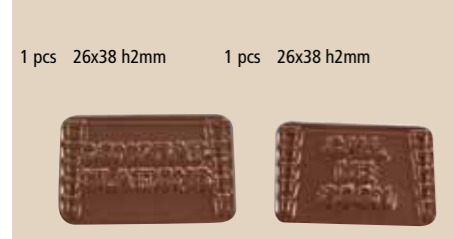
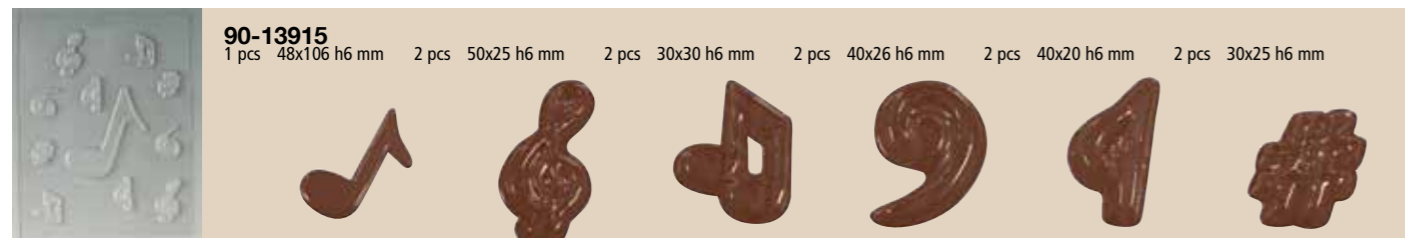

STAMPI IN POLIETILENE - OCCASIONI SPECIALI  
POLYETHYLENE MOULDS - SPECIAL OCCASIONS



# STAMPI IN POLIETILENE - ANIMALI POLYETHYLENE MOULDS - ANIMALS

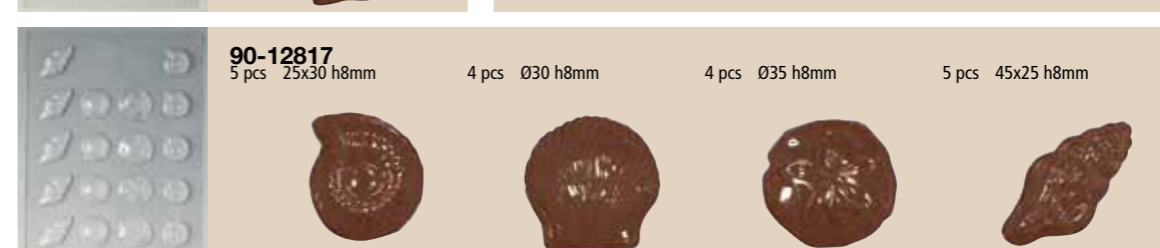
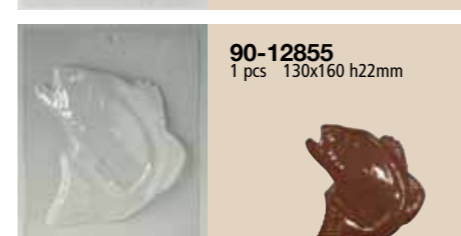
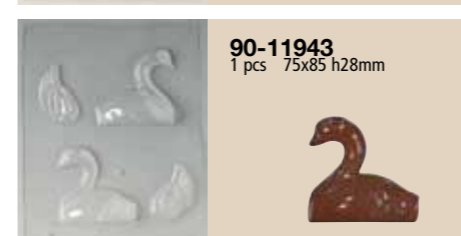
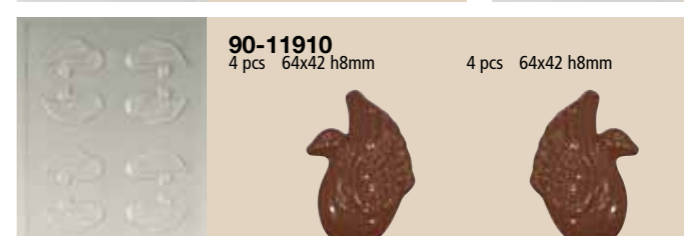
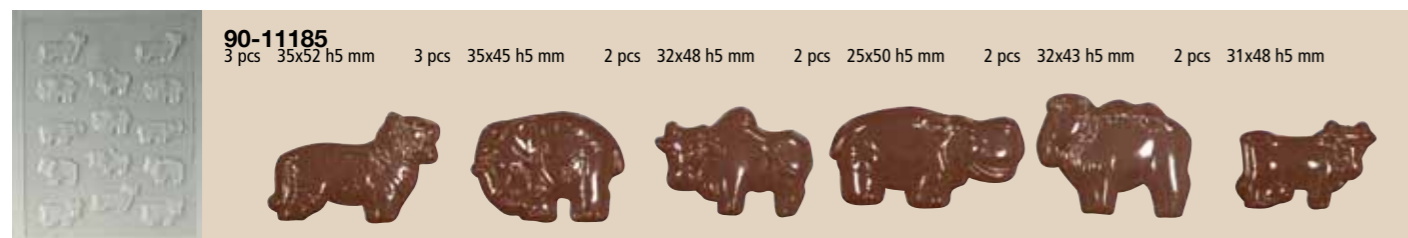
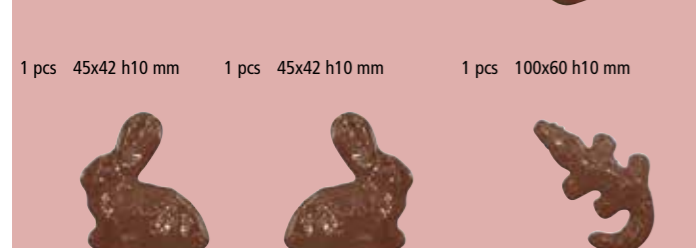

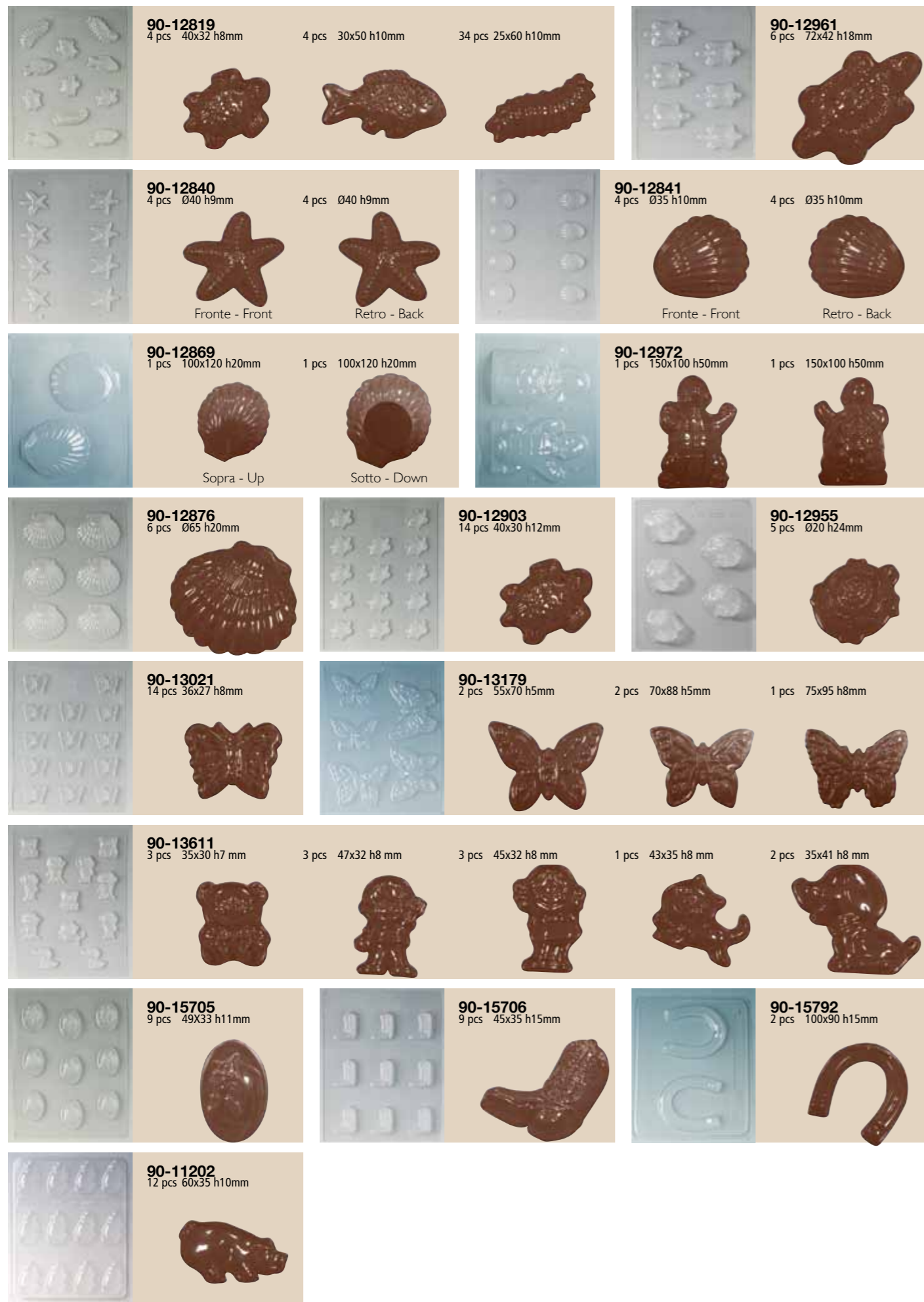

## STAMPI IN POLIETILENE - LETTERE E NUMERI POLYETHYLENE MOULDS - LETTERS & NUMBERS

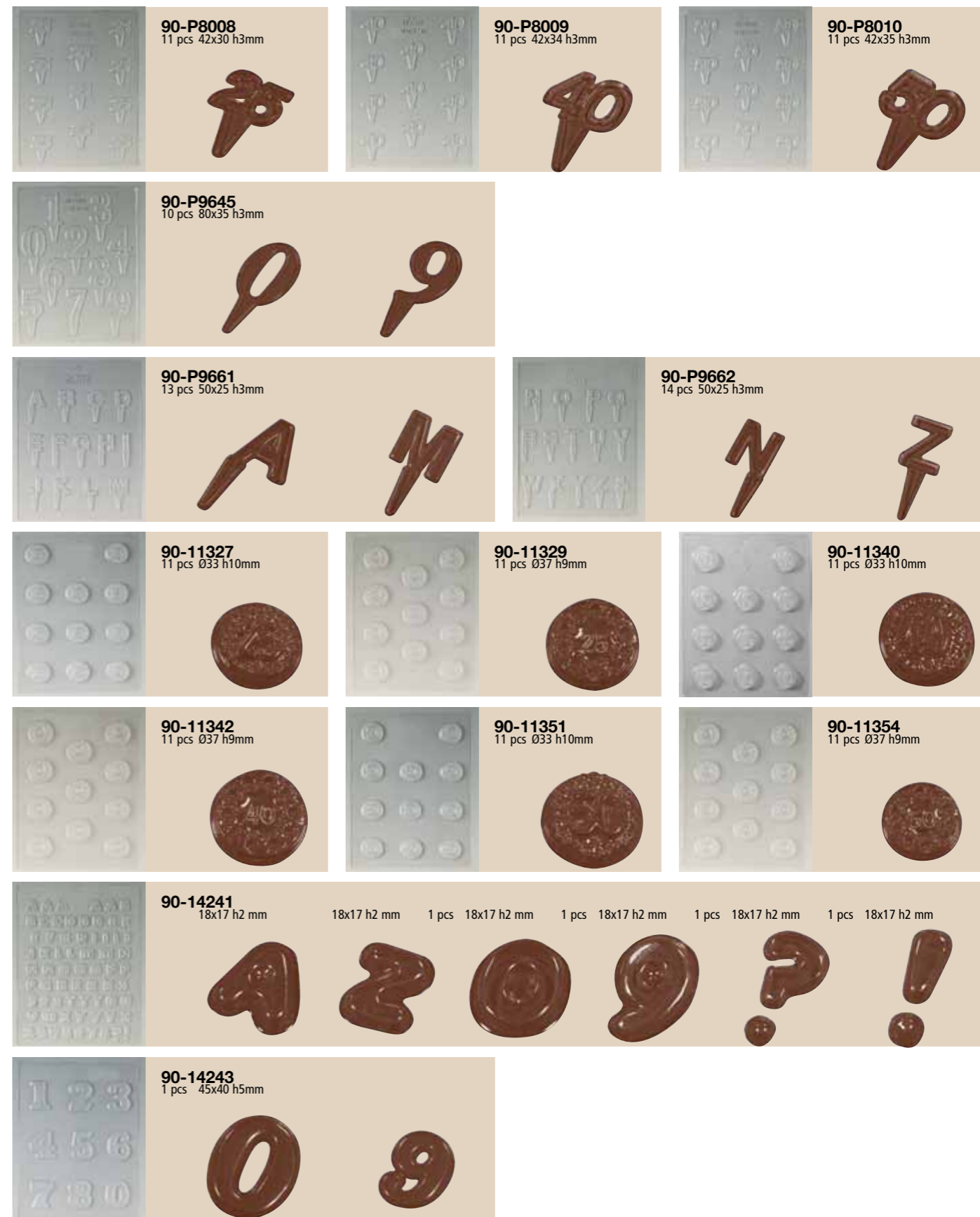

## VETRINA E VASSOI PER PRALINE CHOCOLATES DISPLAY CASES AND TRAYS

Accessori interni non inclusi - Internal accessories not included

Cod. Misure - Size

**VP00101** 60x36cm - H16cm

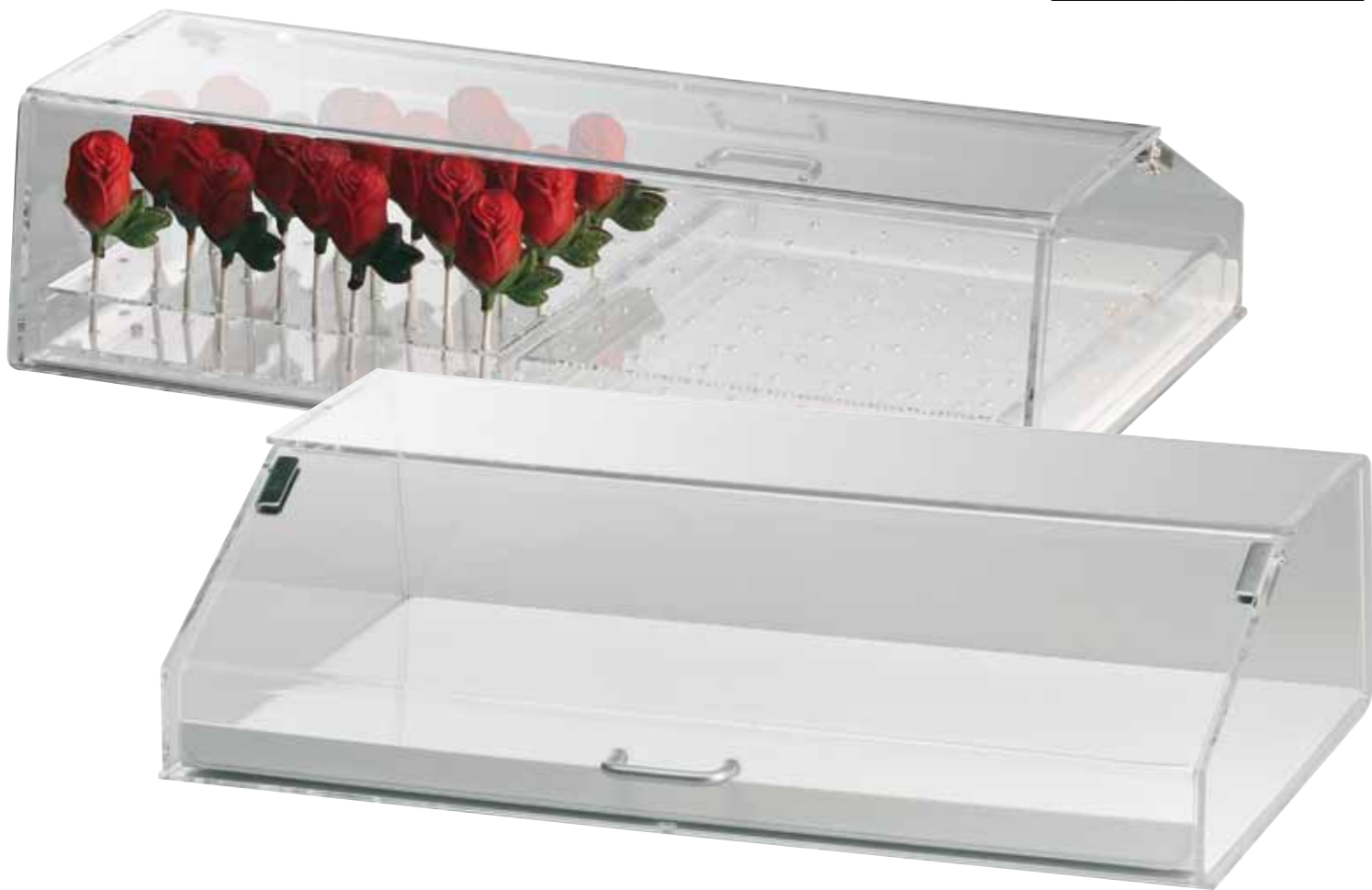

## ACCESSORI - ACCESSORIES

Cod. Descrizione - Description Misure - Size Colore - Colors

**VP00401** Vassoio/Tray 34x11cm - H2cm Trasp. - Transparent  
**VP00501** Ripiano/Plate 32x9cm - H0,2cm Trasp. - Transparent

Cod. Descrizione - Description Misure - Size Colore - Colors

**VP00700** Vassoio/Tray 18x29cm - H2,5cm Bianco / White  
**VP00801** Ripiano/Plate 13x24cm - H0,2cm Trasp. - Transparent

## VASSOI PER PRALINE TRAYS FOR CHOCOLATES

Cod. Descrizione - Description Misure - Size Colore - Colors

**VP00500** Vassoio/Tray 32x20cm - H2,5cm Bianco / White  
**VP00601** Ripiano/Plate 20x15cm - H0,2cm Trasp. - Transparent

Cod. Descrizione - Description Misure - Size Colore - Colors

**VP00206** Vassoio/Tray 17x17cm - H2cm Monosat. - glazed  
**VP00301** Ripiano/Plate 16,5x16,5cm - H0,2cm Trasp. - Transparent

Cod. Descrizione - Description Misure - Size Colore - Colors

**VP00906** Vassoio/Tray 10x50cm - H2cm Monosat. - glazed  
**VP01001** Ripiano/Plate 9,5x49,5cm - H0,2cm Trasp. - Transparent

Cod. Descrizione - Description Misure - Size Colore - Colors

**VP01106** Vassoio/Tray 17x23cm - H2cm Monosat. - glazed  
**VP01201** Ripiano/Plate 16,5x22,5cm - H0,2cm Trasp. - Transparent

## ALZATINA PORTA PRALINE DISPLAY FOR PRALINES

Alzatina in Plexiglass porta praline o mignon  
Plexiglass display for praline and mignon

Cod. Misure - Size

**COD. 604** 220x270 h300





# IMBALLI PER CIOCCOLATINI PACKAGING FOR CHOCOLATES



Cod.	Descr.	Misure - Size	pack
<b>MSC201</b>	6 alveoli	10x11,5 h 2,3cm	25 pcs
<b>MSC202</b>	12 alveoli	21x10 h 2,3cm	25 pcs
<b>MSC203</b>	18 alveoli	21x13,5 h 2,3cm	25 pcs
<b>MSC204</b>	24 alveoli	21x17 h 2,3cm	25 pcs

Scatole per cioccolatini in plastica con bordo satinato, alveoli 32x27mm e coperchio trasparente.  
Boxes for chocolates with alveoli 32x27mm and cover in transparent plastic. Glazed rim.



Cod.	Descr.	Misure - Size	pack
<b>MSC501</b>	4 binari / lines base 3x9cm	20x12 h 3,5cm	25 pcs
<b>MSC502</b>	6 binari / lines base 3x15cm	27x17,5 h 3,5cm	25 pcs
<b>MSC503</b>	7 binari / lines base 3x17,5cm	31x19 h 3,5cm	25 pcs

Scatole per cioccolatini base satinata, coperchio in plastica trasparente con binari trasparenti.  
Boxes for chocolates with glazed bottom, lid in transparent plastic with transparent lines.



Cod.	Descr.	Misure - Size	pack
<b>MSC001</b>	5 alveoli	16x4 h 2 cm	25 pcs
<b>MSC002</b>	9 alveoli	11,2x9,7 h 2 cm	25 pcs
<b>MSC003</b>	12 alveoli	22x6,5 h 2 cm	25 pcs
<b>MSC004</b>	20 alveoli	16x15 h 2 cm	25 pcs

Scatole per cioccolatini in plastica trasparente con alveoli 32x27mm trasparenti.  
Boxes for chocolates in transparent plastic with transparent alveoli 32x27mm



Cod.	Descr.	Misure - Size	pack
<b>MSC101</b>	5 alveoli	16x4 h 2 cm	25 pcs
<b>MSC102</b>	9 alveoli	11,2x9,7 h 2 cm	25 pcs
<b>MSC103</b>	12 alveoli	22x6,5 h 2 cm	25 pcs
<b>MSC104</b>	20 alveoli	16x15 h 2 cm	25 pcs

Scatole per cioccolatini in plastica satinata con alveoli 32x27mm trasparenti.  
Box for chocolates in glazed plastic with transparent alveoli 32x27mm.



Cod.	Descr.	Misure - Size	pack
<b>MSC300</b>	Set 3 cubi / Set 3 cubes	6x6 h 6 - 7x7 h 7 - 8x8 h 7,5cm	10 pcs

Set 3 cubi in plastica satinata.  
Set 3 cubes in glazed plastic.

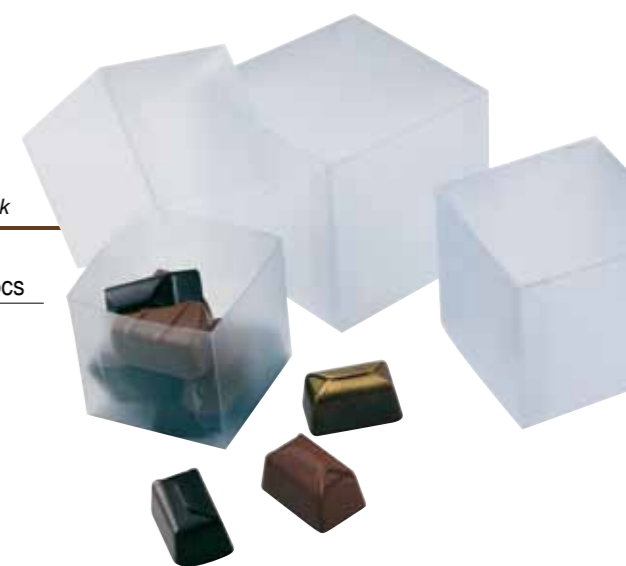

Cod.	Descr.	Misure - Size	pack
<b>MSC400</b>	Set 3 tubi / Set 3 tubes	Ø5 h 12 - Ø6 h 12 - Ø7 h 12cm	10 pcs

Set 3 tubi in plastica satinata.  
Set 3 tubes in glazed plastic.



## STAMPO UOVO SEZIONATO SECTIONED EGG MOULD

Componi il tuo uovo pasquale in modo originale ed alternativo. Unisci le sezioni di cioccolato creando la composizione che incontra il desiderio del tuo cliente. Un nuovo modo di nascondere e scoprire una piacevole sorpresa, un modo alternativo di gustare un semifreddo avvolto da uno strato di cioccolato, un elegante uovo pasquale che sa emozionare anche i gusti estetici più raffinati.

Create your own Easter egg in an original and alternative way. Combine the chocolate sections creating the composition that meets the desire of your customer. This is a new way to hide and find a pleasant surprise, an alternative way of enjoying a semifreddo wrapped in a layer of chocolate, a luxury Easter egg that can appeal even the most refined aesthetic tastes.



Cod.	Misure - Size	Gr
<b>20-U1010</b>	H 130	100 gr

Uovo sezionato piccolo composto da 4 sezioni.  
Sectioned small egg consists of 4 sections.



Cod.	Misure - Size	Gr
<b>20-U1011</b>	H 180	250 gr

Uovo sezionato grande composto da 5 sezioni.  
Sectioned large egg consists of 5 sections.

Riempire di cioccolato lo stampo, vibrare per alcuni secondi per togliere le bolle in eccesso e per creare lo spessore necessario;  
Svuotare lo stampo;  
Lisciarne i bordi e lasciar riposare lo stampo per qualche minuto;  
Procedere alla sformatura delle sezioni dell'uovo;  
Unire le sezioni seguendo la linea guida.

Fill the mould with chocolate, shake it for several seconds to remove excess air bubbles and create the required thickness;  
Empty the mould;  
Smooth the edges and leave the mould to stand for a few minutes;  
Remove the pieces of the egg;  
Join the sections along the guide line.

## STAMPO UOVO - EGG MOULD

Stampo mezzo guscio in plastica rigida (PETG).  
Half shell mould made of strong plastic material (PETG).



Cod.	Misure - Size	* KG - WEIGHT
<b>SUT25X17</b>	25x17cm	0,5 - 1
<b>SUT28X18</b>	28x18,5cm	0,8 - 1,2
<b>SUT34X25</b>	32,5x24cm	1,5 - 2
<b>SUT40X27</b>	39x26,5cm	2 - 2,5
<b>SUT45X32</b>	43,5x31cm	2,5 - 3,5
<b>SUT54X36</b>	52x35cm	4 - 6
<b>SUT64X43</b>	62x42cm	6 - 8
<b>SUT75X50</b>	74x49cm	8 - 10

\* PESO INDICATIVO  
INDICATIVE WEIGHT

STAMPI IN PLASTICA  
PER MASCHERE DI CIOCCOLATO  
PLASTIC MOULD  
FOR CHOCOLATE MASKS



Cod. *Misure - Size*  
**20-CA001** 125x175x40 mm



Cod. *Misure - Size*  
**20-CA002** 135x175x40 mm



Cod. *Misure - Size*  
**20-CA003** 155x190x40 mm

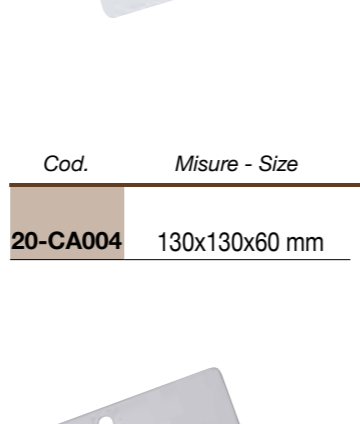

Cod. *Misure - Size*  
**20-CA004** 130x130x60 mm



Cod. *Misure - Size*  
**20-CA005** 135x160x45 mm



Cod. *Misure - Size*  
**20-CA006** 130x180x60 mm

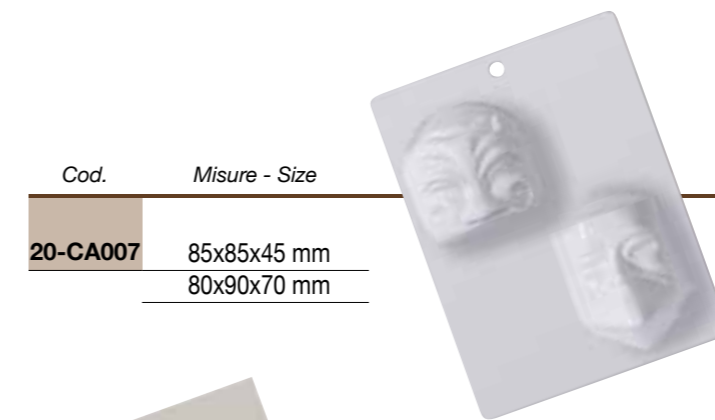

Cod. *Misure - Size*  
**20-CA007** 85x85x45 mm  
80x90x70 mm

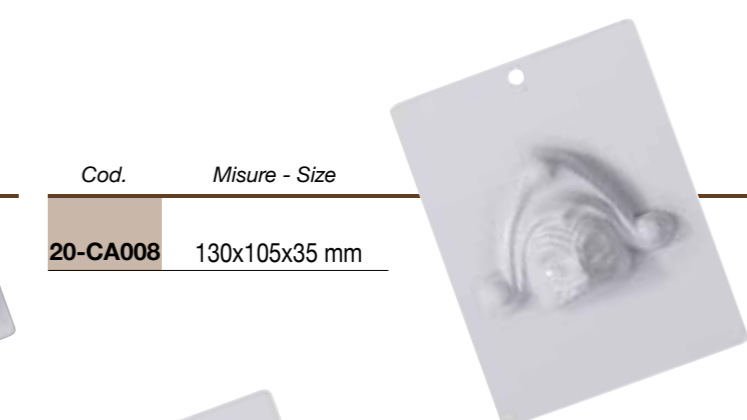

Cod. *Misure - Size*  
**20-CA008** 130x105x35 mm



Cod. *Misure - Size*  
**20-CA009** 105x135x40 mm



Cod. *Misure - Size*  
**20-CA010** 30x45x15 mm



Cod. *Misure - Size*  
**20-CA011** 50x65x20 mm

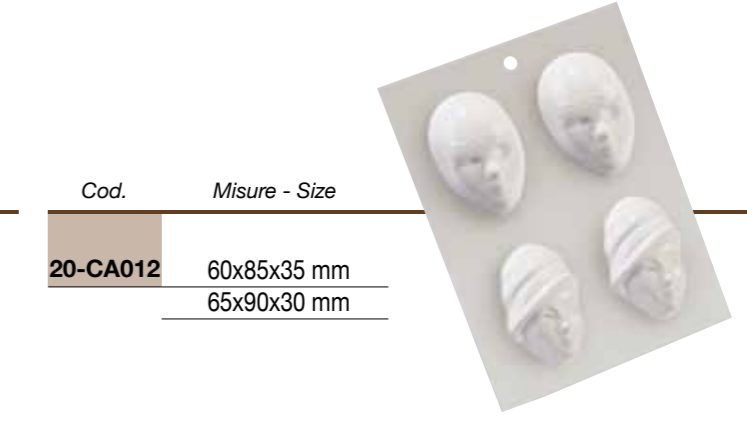

Cod. *Misure - Size*  
**20-CA012** 60x85x35 mm  
65x90x30 mm



Cod. *Misure - Size*  
**CARNEVAL1** 205x142x48 mm  
195x142x60 mm  
164x142x55 mm



Cod. *Misure - Size*  
**CARNEVAL2** 160x120x48 mm  
140x132x40 mm  
137x142x45 mm  
115x88x25 mm

## STAMPI CHOCOFUNNY CHOCOFUNNY MOULDS

Lo stampo, realizzato in resistente materiale plastico RIUTILIZZABILE, è composto da due placche trasparenti, una che riporta l'incisione del soggetto nella quale stendere il burro di cacao colorato, e l'altra da posizionare sopra, nella quale inserire lo stecco in plastica (in caso di stampo lollipop) e versare il cioccolato.

Disponibili espositori da banco per la vendita.

Our moulds, made of reusable durable plastic, are made of two transparent plates: one showing the engraving of a subject in which you lay your coloured cocoa butter, and the other one, to be placed above, in which you put the plastic stick (for lollipop moulds) and pour the chocolate. Display for sale available.



1 - Stendere il burro di cacao o del cioccolato colorato temperato sulla placca incisa ChocoFunny;  
2 - Lasciar cristallizzare il cioccolato e successivamente pulire con un panno le eventuali sbavature.  
3 - Posizionare sopra alla placca con l'incisione la placca forata, fissandola con i due perni. Inserire lo stecco all'interno della guida preposta.  
4 - Con l'aiuto di una sac a poche riempire la sagoma con il cioccolato;  
Lasciar cristallizzare il cioccolato prima di staccare i soggetti dalla placca.  
5 - Per la sformatura fare una leggera pressione con i pollici e se necessario staccare i soggetti delicatamente anche dalla placca sagomata.

1 - Spread tempered cocoa butter or coloured chocolate on the engraved ChocoFunny plate using a rubber spatula;  
2 - Let the chocolate crystallize and then wipe off with a cloth any excess of chocolate  
3 - Place the pierced plate over that with the engraving fixing it with two pins and insert the stick inside the rail.  
4 - Fill the subject with the chocolate by using a pastry bag;  
Let the chocolate crystallize before removing the subject from the plate.  
5 - Make a slight pressure with your thumbs to take the subjects out of the mould and, if necessary, gently remove them even from the shaped plate.



## STAMPI CHOCOFUNNY LOLLIPOP CHOCOFUNNY LOLLIPOP MOULDS

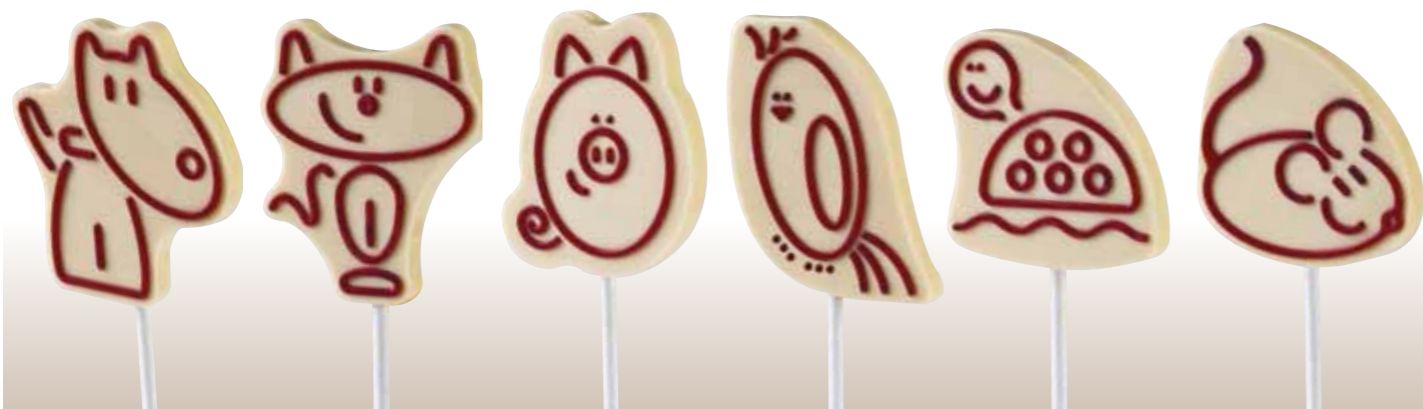

Cod. Misure - Size cap. Gr.

**20-C017** 60x70 6 pcs 30 gr approx



Cod. Misure - Size cap. Gr.

**20-C024** 60x70 6 pcs 30 gr approx



Cod. Misure - Size pack

Bastoncini per lollipops.  
Sticks for lollipops.

**20-B002** 105mm 100  
**20-B001** 105mm 400



Cod. Misure - Size pack

Sacchettini per lollipops.  
Bags for lollipops

**20-S002** 80x120mm 100  
**20-S001** 80x120mm 400

## PORTA LOLLIPOP IN PLEXIGLASS PLEXIGLASS DISPLAY FOR LOLLIPOPS



Cod. Misure - Size cap.

**EL309** 295x70 h125 30 pcs

Cod. Misure - Size cap.

**EL201** 450x240 h145 66 pcs



Cod. Misure - Size cap.

**EL101** 345x280 h40 56 pcs



Cod. Misure - Size cap.

**EL203** 140x175 h370 19 pcs



Cod. Misure - Size cap.

**EL209** 140x175 h370 19 pcs





STAMPI CHOCOFUNNY LETTERE E NUMERI  
CHOCOFUNNY LETTERS AND NUMBERS



Cod. Misura - Size cap. Gr.

20-C018 40x42 9 pcs 2/4 gr approx

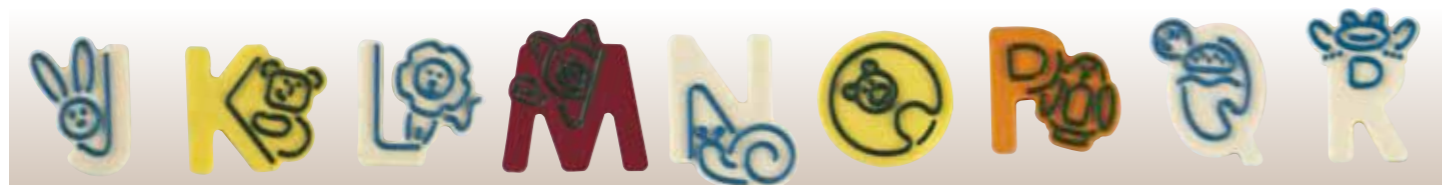

Cod. Misura - Size cap. Gr.

20-C019 40x42 9 pcs 2/4 gr approx



Cod. Misura - Size cap. Gr.

20-C020 40x42 8 pcs 2/4 gr approx

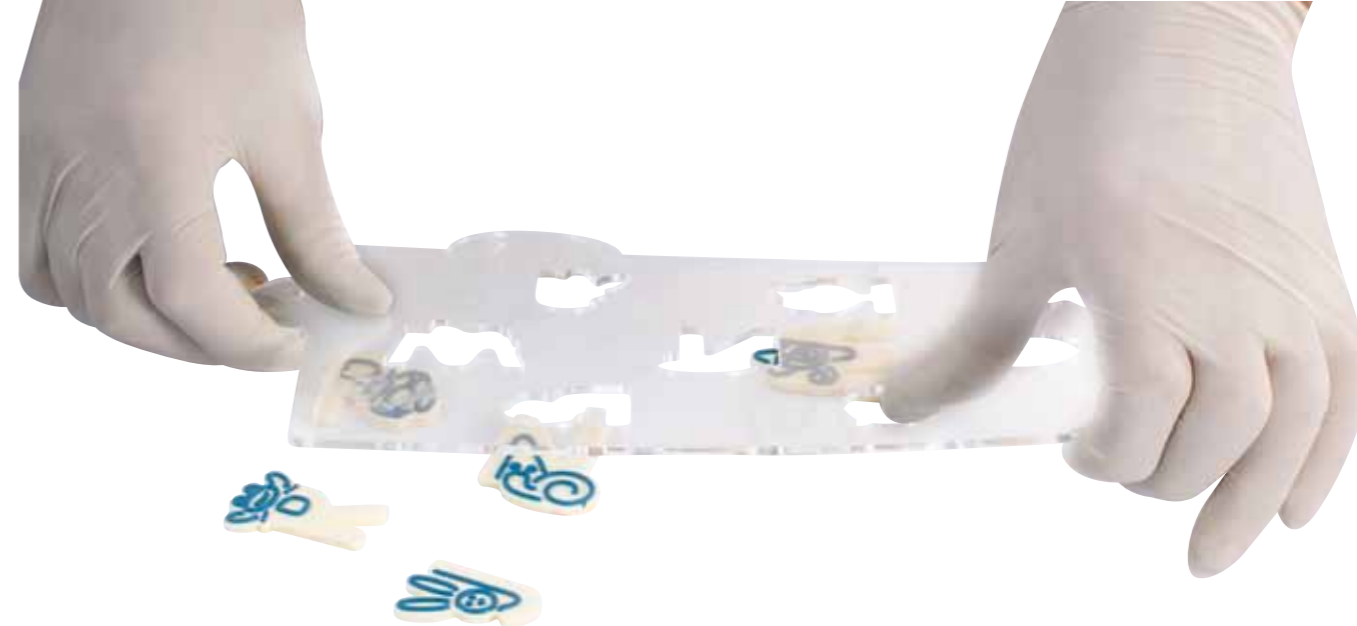

Cod. Misura - Size cap. Gr.

20-C021 74x62 5 pcs 12/14 gr approx



Cod. Misura - Size cap. Gr.

20-C022 74x62 5 pcs 12/14 gr approx



Cod. Misura - Size cap. Gr.

20-C023 41x50 10 pcs 4/6 gr approx

STAMPI CHOCOFUNNY SOGGETTI  
CHOCOFUNNY SUBJECTS MOULDS

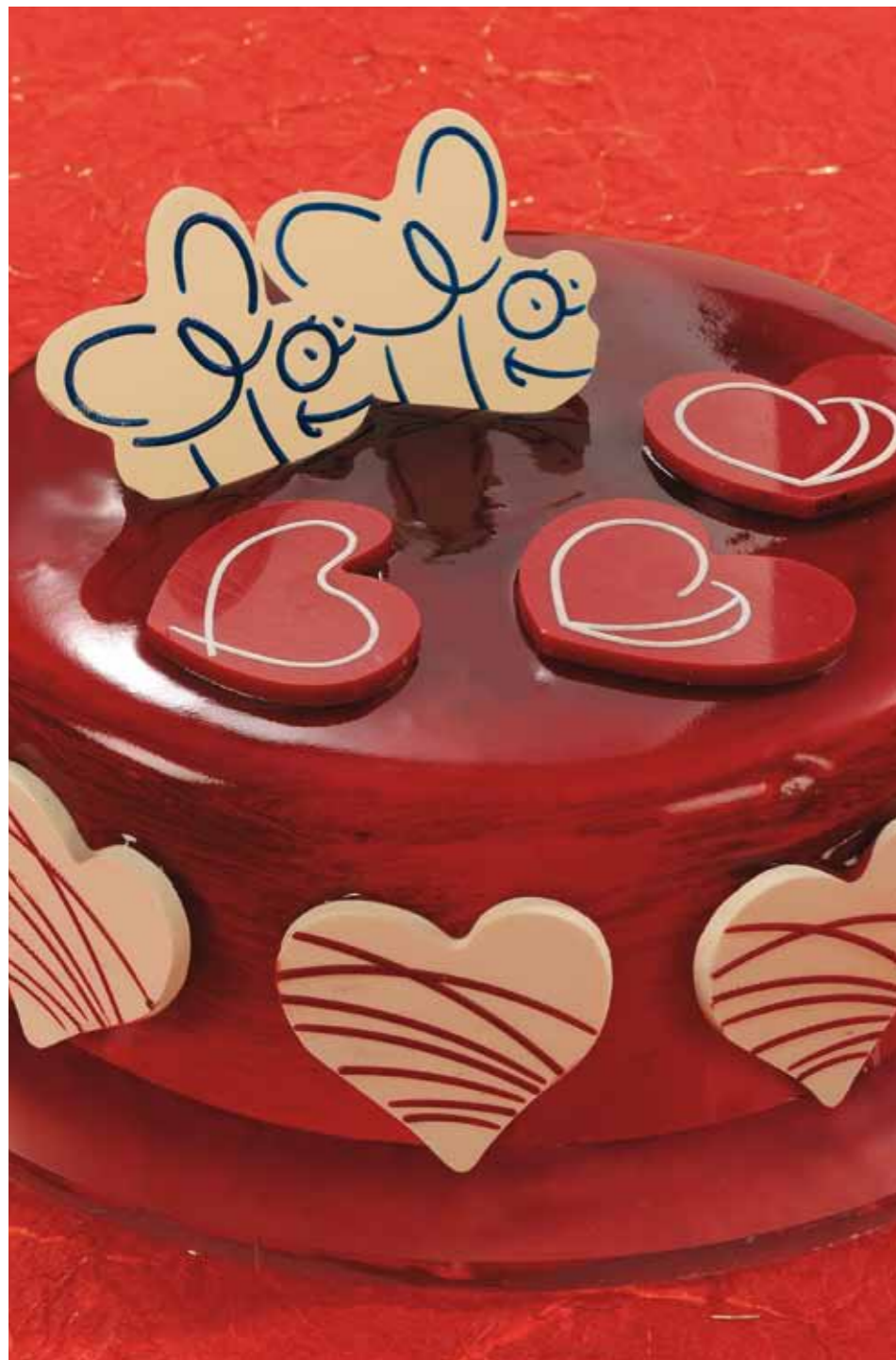

Ape Bee



Cod.	Misure - Size	cap.
20-C007	47x46 mm	12 pcs

Sole Sun



Cod.	Misure - Size	cap.
20-C008	Ø48 mm	11 pcs

Farfalla Butterfly



Cod.	Misure - Size	cap.
20-C009	34x46 mm	12 pcs

Coniglio con carota  
Bunny with carrot



Cod.	Misure - Size	cap.
20-C001	49x45 mm	11 pcs

Farfalla Butterfly



Cod.	Misure - Size	cap.
20-C010	56x45 mm	8 pcs

Farfalla Butterfly



Cod.	Misure - Size	cap.
20-C011	33x54 mm	12 pcs

Ape Bee



Cod.	Misure - Size	cap.
20-C012	39x46 mm	11 pcs

Gallo Rooster



Cod.	Misure - Size	cap.
20-C002	55x60 mm	10 pcs

Fiore Flower



Cod.	Misure - Size	cap.
20-C013	45x41 mm	12 pcs

Cuori Hearts



Cod.	Misure - Size	cap.
20-C014	44x39 mm	4x3 pcs

Uovo Egg



Cod.	Misure - Size	cap.
20-C003	39x50 mm	11 pcs

Cuore Heart



Cod.	Misure - Size	cap.
20-C015	42x39 mm	12 pcs

Cuore Heart



Cod.	Misure - Size	cap.
20-C016	43x40 mm	12 pcs

Uovo Egg



Cod.	Misure - Size	cap.
20-C004	35x45 mm	14 pcs

Coniglio Bunny



Cod.	Misure - Size	cap.
20-C005	45x59 mm	8 pcs

Pulcino Chick



Cod.	Misure - Size	cap.
20-C006	42x62 mm	8 pcs



## TAPPETINI PER DECORAZIONI IN CIOCCOLATO MATS FOR CHOCOLATE DECORATIONS

Fogli in silicone per la produzione di decorazioni in cioccolato.  
Misura 39x29cm - Spessore 1,5mm.  
Silicone sheets for chocolate decorations. Size 39x29cm  
Thickness 1,5mm.

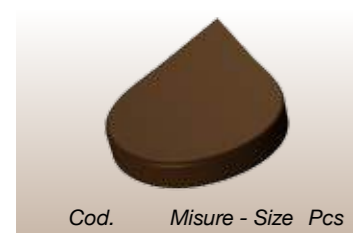

Cod. Misure - Size Pcs

**CHASIL1** 35x25mm 60



Cod. Misure - Size Pcs

**CHASIL2** 35x33mm 48

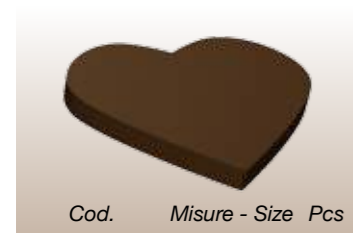

Cod. Misure - Size Pcs

**CHASIL3** 35x25mm 48

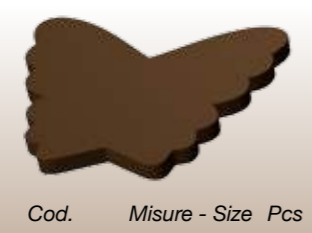

Cod. Misure - Size Pcs

**CHASIL4** 60x53mm 20

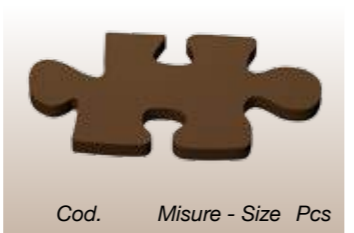

Cod. Misure - Size Pcs

**CHASIL5** 50x78mm 18

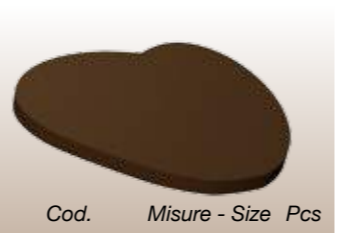

Cod. Misure - Size Pcs

**CHASIL6** 58x48mm 25

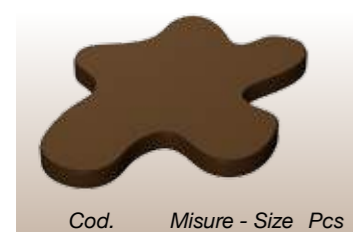

Cod. Misure - Size Pcs

**CHASIL7** 57x50mm 30

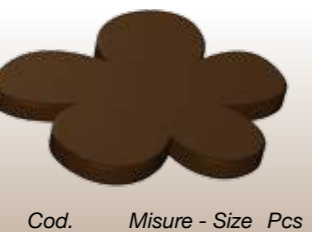

Cod. Misure - Size Pcs

**CHASIL8** 55x50mm 25

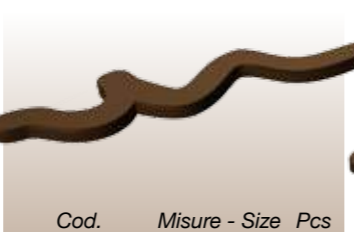

Cod. Misure - Size Pcs

**CHASIL9** 102x27mm 18

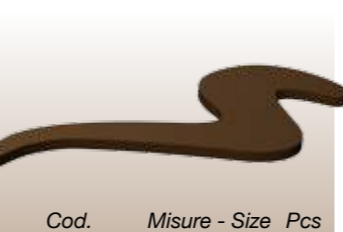

Cod. Misure - Size Pcs

**CHASIL10** 97x30mm 18

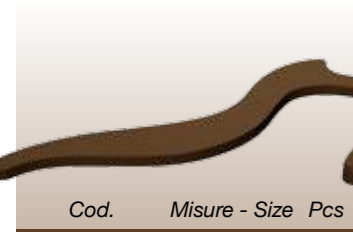

Cod. Misure - Size Pcs

**CHASIL11** 102x27mm 24

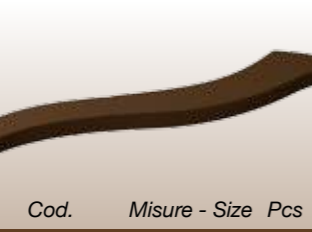

Cod. Misure - Size Pcs

**CHASIL12** 102x18mm 30

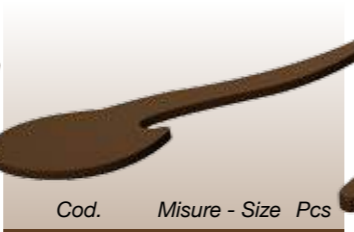

Cod. Misure - Size Pcs

**CHASIL13** 104x26mm 24

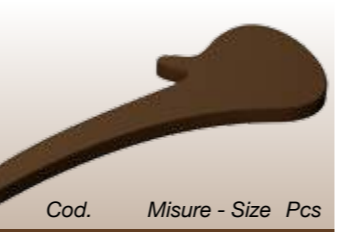

Cod. Misure - Size Pcs

**CHASIL14** 99x37mm 40

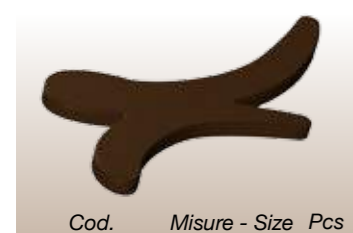

Cod. Misure - Size Pcs

**CHASIL15** 82x42mm 24



Cod. Misure - Size Pcs

**CHASIL16** Ø26mm 48



Cod. Misure - Size Pcs

**CHASIL17** Ø36mm 36

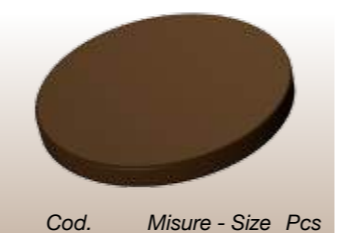

Cod. Misure - Size Pcs

**CHASIL18** Ø42mm 30

## FORMA IN GOMMA RUBBER FORM

Forma in gomma per decorazioni di cioccolato.  
Rubber mould for chocolate decorations



Cod. Misure - Size

**GRECA01** 300x100 h10mm

## FORCHETTE PER CIOCCOLATO CHOCOLATE FORKS

Set 10 forchette in filo di acciaio inox con manico in plastica.  
10 steel forks set with plastic handle.

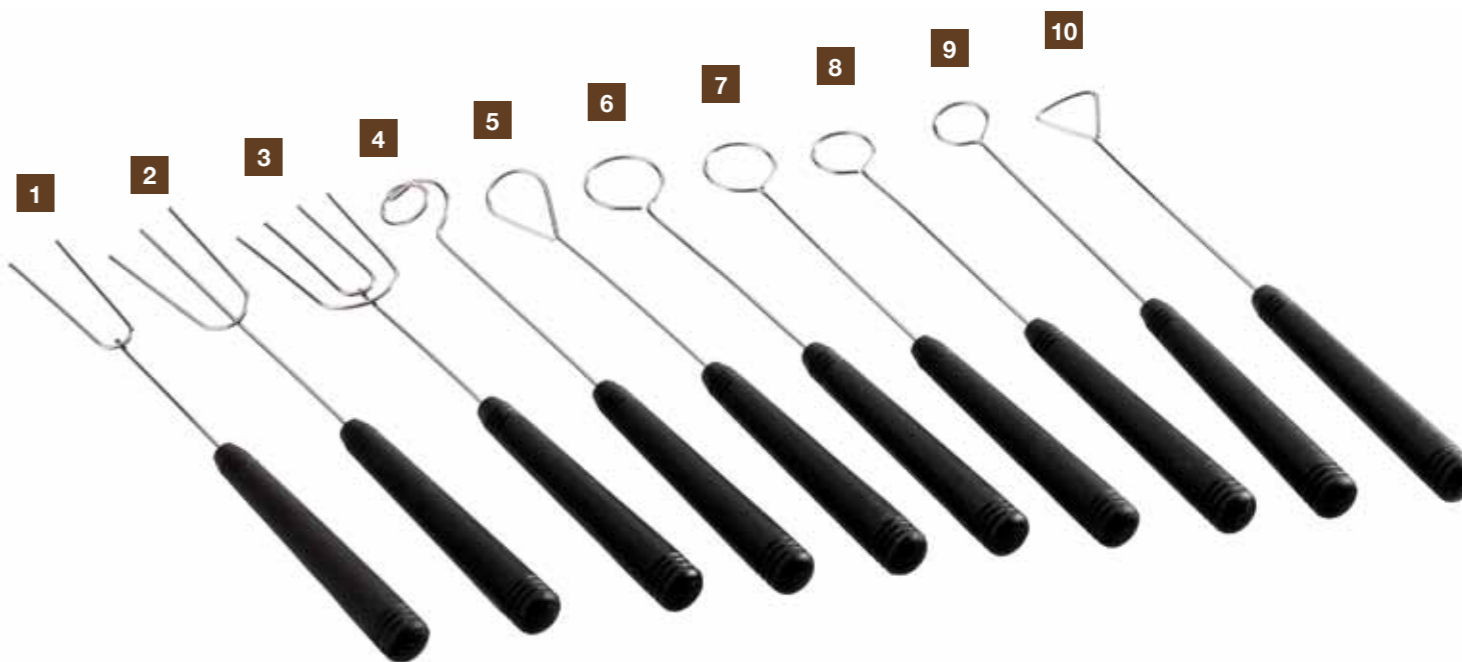

Cod.	Descr.
<b>CHOCOFORK</b>	Set 10 pcs

Cod.	Descr.
<b>1 CHOC0101</b>	2 rebbi / 2 tines
<b>2 CHOC0102</b>	3 rebbi / 3 tines
<b>3 CHOC0103</b>	4 rebbi / 4 tines
<b>4 CHOC0104</b>	spirale / spiral
<b>5 CHOC0110</b>	goccia / drop

Cod.	Descr.
<b>6 CHOC0106</b>	Ø20mm
<b>7 CHOC0107</b>	Ø18mm
<b>8 CHOC0105</b>	Ø16mm
<b>9 CHOC0108</b>	Ø14mm
<b>10 CHOC0109</b>	triangolo / triangle



## RASCHIE PER CIOCCOLATO SCRAPERS FOR CHOCOLATE

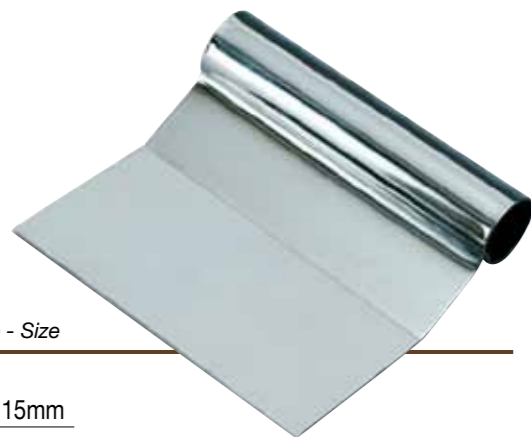

Cod. *Misure - Size*  
**RC115** 120x115mm

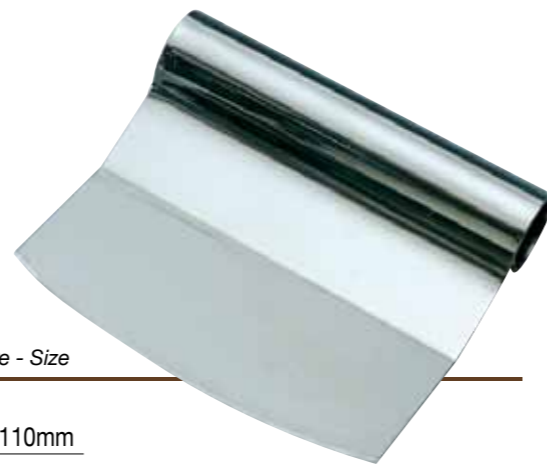

Cod. *Misure - Size*  
**RC110** 120x110mm

## PIASTRE CON PIEDINI GRATES WITH FEET



Cod. *Misure - Size*  
**PR30X30** 30x30cm  
**PR40X60** 40x60cm  
**PR50X50** 50x50cm

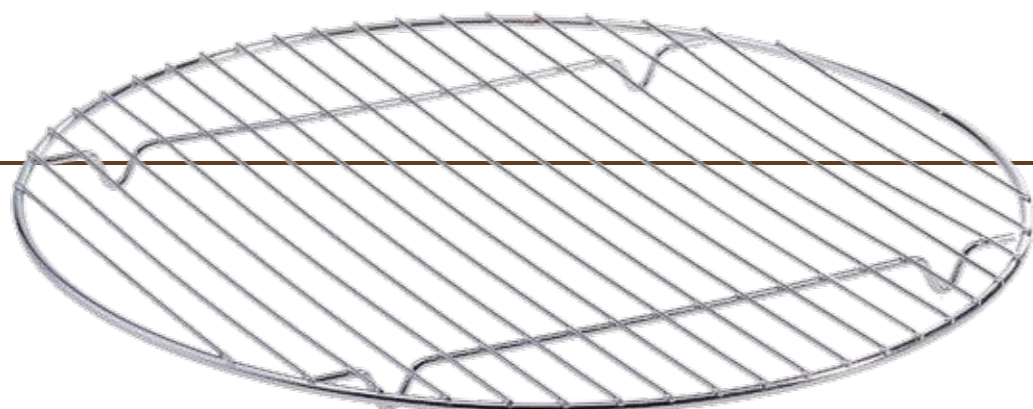

Cod. *Misure - Size*  
**PR30** Ø30cm  
**PR40** Ø40cm



## QUADRI PER GANACHE FRAMES FOR GANACHE

Cod.	Misure esterne - External size	Misure interne - Internal size
<b>QG3</b>	400x400 h3 mm	360x360 mm
<b>QG5</b>	400x400 h5 mm	360x360 mm

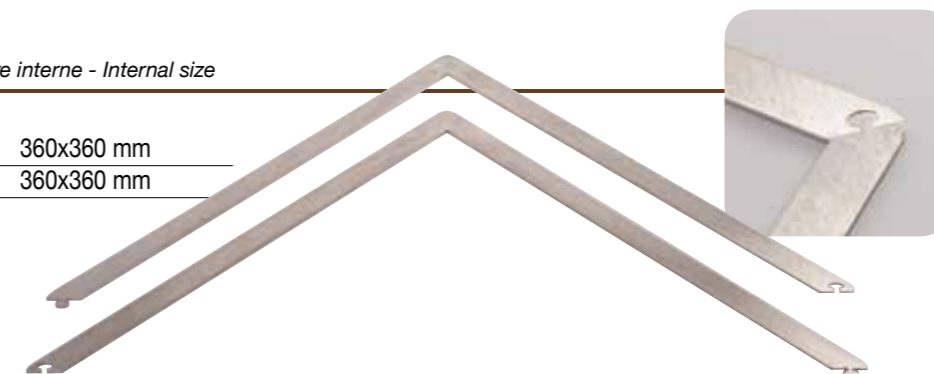

Cod.	Misure esterne - External size	Misure interne - Internal size
<b>QG10</b>	380x380 h10 mm	360x360 mm
<b>QG15</b>	380x380 h15 mm	360x360 mm

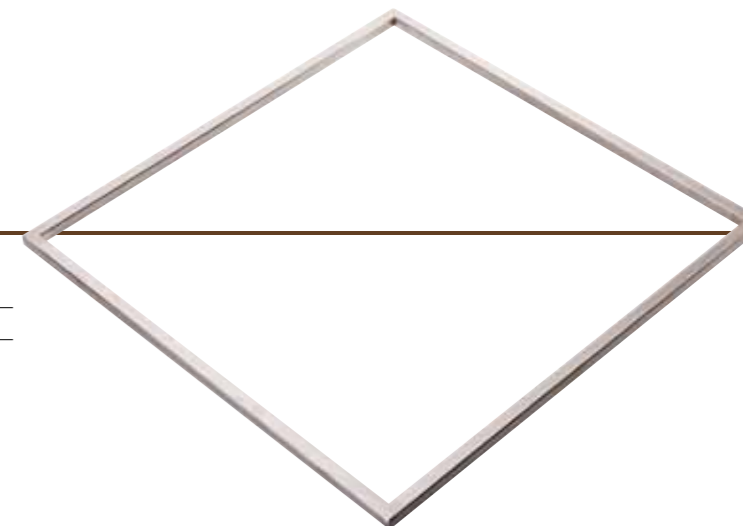

## LASTRE PER CIOCCOLATO SHEETS FOR CHOCOLATE

Lastre in plastica trasparente per realizzare decorazioni di cioccolato in rilievo. Spessore 4,5mm.  
Transparent plastic sheets for relief chocolate decorations. Thickness 4,5mm.

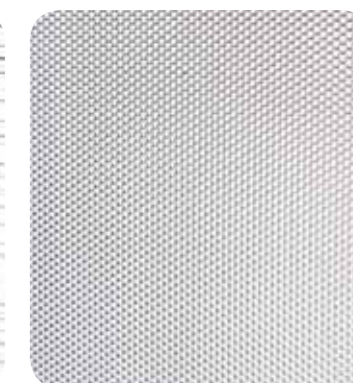

Cod. *Misure - Size*  
**LPR1** 50x40cm

Cod. *Misure - Size*  
**LPR2** 50x40cm

Cod. *Misure - Size*  
**LPR3** 50x40cm

Cod. *Misure - Size*  
**LPR4** 50x40cm

## FOGLI PER CIOCCOLATO CHOCOLATE SHEETS

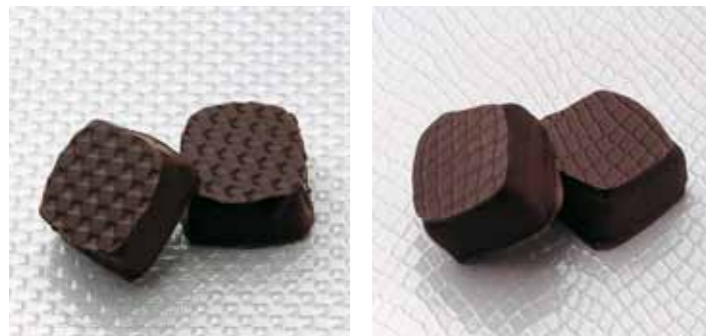

Cod.	Misure - Size	pack
<b>MACL01</b>	360x340	13x1

Kit 13 fogli in plastica trasparente per la realizzazione di decorazioni di cioccolato in rilievo, fantasie varie.  
13 transparent plastic sheets kit for the production of chocolate decorations in relief, different patterns.

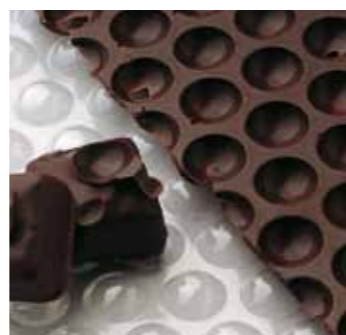

## PIANO RISCALDANTE HEATING PLATE

Piano in acciaio riscaldato elettricamente per la lavorazione del cioccolato e di altri alimenti. Struttura in materiale plastico con ripiano inox removibile. Temperatura max 55° C. Disponibile 110V su richiesta. Electrical Heating surface for chocolate and other food. Plastic structure with removable st. steel plate. Temperature max 55° C. Available 110v on demand.

Cod.	Misure - Size	Caratt. - Characteristics
<b>PR001</b>	32x40 h 11,5 cm	230V - 50/60 Hz - 0.35A - 80W



## FONTANINA PICCOLA PER CIOCCOLATO SMALL CHOCOLATE FOUNTAIN

Realizzata in acciaio inox. Perno centrale in materiale plastico resistente ad alte temperature. Mantiene la cioccolata alla temperatura di 36/39°C. Facile da usare e da pulire. Made of stainless steel. The auger is made of heat resistant plastic. It keeps the chocolate at 36/39°C. Easy to be used and cleaned.

Cod.	Misure - Size	Caratt. - Characteristics
<b>CHOCOFONT</b>	Ø 210mm x h 390mm	220 - 240V - 50 Hz - 0,77A - 170W



## ANELLO PER FONTANINA RING FOR CHOCOLATE FOUNTAIN

Copri fontanina con comodi ripiani porta-coppette. Ring cover for Chocofont with useful shelves.

Cod.	Colore - Color	Misure - Size
<b>CHOCORING</b>	rosso - red	Ø 520mm x h 160mm
<b>CHOCORING06</b>	satinato - glazed	Ø 520mm x h 160mm



## FONTANA GRANDE PER CIOCCOLATO BIG CHOCOLATE FOUNTAIN

Realizzata in acciaio inox.  
Perno centrale in materiale plastico resistente ad alte temperature.  
Mantiene la cioccolata alla temperatura di 36/39°C.  
Facile da usare e da pulire.  
Made of stainless steel.  
The auger is made of heat resistant plastic.  
It keeps the chocolate at 36/39°C.  
Easy to be used and cleaned.



Cod.	Misure - Size	Caratt. - Characteristics
<b>CHOCOBIG</b>	Ø38 h80 cm	230V - 50 Hz - 1.6A - 370W

## ANELLO PER FONTANA GRANDE RING FOR BIG CHOCOLATE FOUNTAIN

Copri fontanina con comodi ripiani porta-coppette.  
Ring cover for Chocofont with useful shelves.



Cod.	Colore - Color	Misure - Size
<b>CHOCOBIGRING</b>	rosso - red	Ø65 h17 cm
<b>CHOCOBIGRING06</b>	satinato - glazed	Ø65 h17 cm

## FONTANA GRANDE PER CIOCCOLATO BIG CHOCOLATE FOUNTAIN

Realizzata in acciaio inox.  
Perno centrale in materiale plastico resistente ad alte temperature.  
Mantiene la cioccolata alla temperatura di 36/39°C.  
Facile da usare e da pulire. Cap. 9 Lt  
Made of stainless steel.  
The auger is made of heat resistant plastic.  
It keeps the chocolate at 36/39°C.  
Easy to be used and cleaned. Cap. 9 Lt



Cod.	Misure - Size	Caratt. - Characteristics
<b>20-4000</b>	Ø44 h100 cm	230V 50/60Hz - 2,5A - 450W

## ANELLO PER FONTANA GRANDE RING FOR BIG CHOCOLATE FOUNTAIN

Anello copri motore fontana con due ripiani in plexiglass satinato forma ovalizzata.  
Fountain motor-cover ring with two oval shaped satinized plexiglass shelves.



Cod.	Colore - Color	Misure - Size
<b>20-R4000</b>	satinato - glazed	810x810 h 165 mm

# SCIOGLITORE PER CIOCCOLATO A SECCO CHOCOLATE DRY HEAT CHOCOLATE MELTERS

Realizzato in materiale plastico termoresistente. Vasca e coperchio in acciaio inox removibile. Il termostato manuale mantiene il cioccolato alla temperatura desiderata. 220V o 110V.

Thermoresistant plastic material. Removable stainless steel basin and lid. Manual thermostat to control the temperature desired. 220V or 110V.



Cod.	Misure - Size	Cap.	Vasca - Basin
<b>MC01</b>	41x23 13,5cm	3,6 Lt	32,5x18 h10cm

Cod.	Misure - Size	Cap.	Vasca - Basin
<b>MC02</b>	40x33 13,5cm	6 Lt	32x26,5 h10cm

Cod.	Misure - Size	Cap.	Vasca - Basin
<b>MC03</b>	44x39 13,5cm	9 Lt	35,3x32 h10cm

Cod.	Misure - Size	Cap.	Vasca - Basin
<b>MC04</b>	60x38 h13,5cm	13,7 Lt	53x32,5 h10cm

Cod.	Misure - Size	Cap.	Vasca - Basin
<b>MC05</b>	23x26 h12,5cm	1,5 Lt	15,5x14 h10cm

Cod.	Misure - Size	Cap.	Vasca - Basin
<b>MC06</b>	76x26 h12,5cm	4x1,5Lt	15,5x14 h10cm

Cod.	Misure - Size	Cap.	Vasca - Basin
<b>MC07</b>	38x25 13,5cm	3x0,8Lt	15x8,3 h10cm

Cod.	Misure - Size	Cap.	Vasca - Basin
<b>MC08</b>	26x40,5 13,5cm	2x1,5Lt	15,5x14 h10cm



# TERMOMETRO THERMOMETER

Termometro digitale per cioccolato. Misurazione Celsius e Fahrenheit.  
Digital thermometer for chocolate, measures in both Celsius and Fahrenheit.

Cod.
<b>50T001</b>



## SCIOGLITORE DIGITALE PER CIOCCOLATO A SECCO DIGITAL DRY HEAT CHOCOLATE MELTERS

Realizzato in materiale plastico termoresistente, con vasca e coperchio in acciaio inox removibile. Il termostato digitale e la speciale sonda silconica posizionata all'interno della vasca e immersa nel prodotto, permettono di impostare e mantenere con precisione la temperatura desiderata. 220V o 110V.

Made of thermoresistant plastic material. Removable stainless steel basin and lid with digital thermostat and a special auger, which is placed inside the basin and dip into the chocolate, it is possible to set the temperature and check it constantly. 220V or 110V.



Cod.	Misure - Size	Cap.	Vasca - Basin
<b>MCD01</b>	46x23 13,5cm	3,6Lt	325x180 h100mm

Cod.	Misure - Size	Cap.	Vasca - Basin
<b>MCD02</b>	50x33 13,5cm	6 Lt	320x265 h100mm

Cod.	Misure - Size	Cap.	Vasca - Basin
<b>MCD03</b>	46x38 13,5cm	9 Lt	353x320 h100mm

Cod.	Misure - Size	Cap.	Vasca - Basin
<b>MCD04</b>	68x38 13,5cm	13,7Lt	530x325 h100mm

## MINI SCIOGLITORE PER CIOCCOLATO A SECCO MINI DRY HEAT CHOCOLATE MELTERS



**MiniMeltinChoc**  
MADE IN ITALY

Lo scioglitore a secco per cioccolato MINI-MELTINCHOC può essere utilizzato sia in laboratorio per piccole produzioni di praline e soggetti di cioccolato che in gelateria per la glassatura di gelati e dessert su secco. Il design raffinato incentiva l'esposizione dello scioglitore in negozio favorendone l'utilizzo anche di fronte al pubblico. Realizzato in robusto materiale plastico antiurto. Vaschetta estraibile in alluminio anodizzato. Misure 26x26 h16 cm Misure Vasca: Ø18,5 h10,7 cm Cap. 1,8 LT

MINI-MELTINCHOC dry heat chocolate melters can be used for small productions of pralines and chocolate subjects, as well as in the ice-cream shops for the decorations of ice creams. Because of its modern design, the melter can be used also in the shop in front of the customers. Made of durable impact resistant plastic. Removable basin made of anodized aluminium. Size 26x26 h16 cm Basin: Ø18,5 h10,7 cm Cap. 1,8 LT

Cod.	Colore - Color
<b>MC09G</b>	Grigio - Gray



Cod.	Colore - Color
<b>MC09L</b>	Lilla - Lilac



Cod.	Colore - Color
<b>MC09R</b>	Rosso - Red



Cod.	Colore - Color
<b>MC09V</b>	Verde - Green

